

EMX 15.0.1.2

What's New?

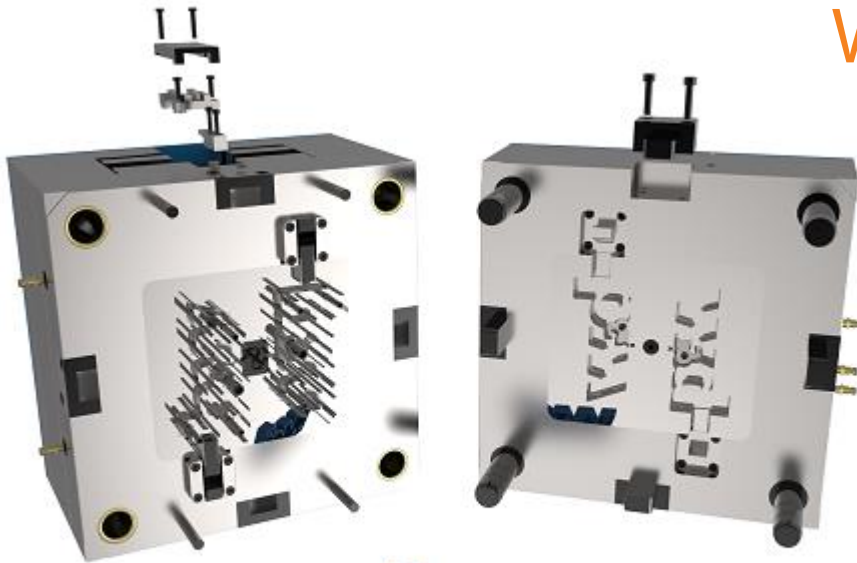

Improvements

- Improved Component Editor
 - Easily create part name rules for assemblies within dat files
 - Improved definition of instance dimensions with right mouse menu
 - etc.
- New config option EXCEL_TEMPALTE_PATH to set up default location for Bill of Material Excel template file

EMX 15.0.0.0

What's New?

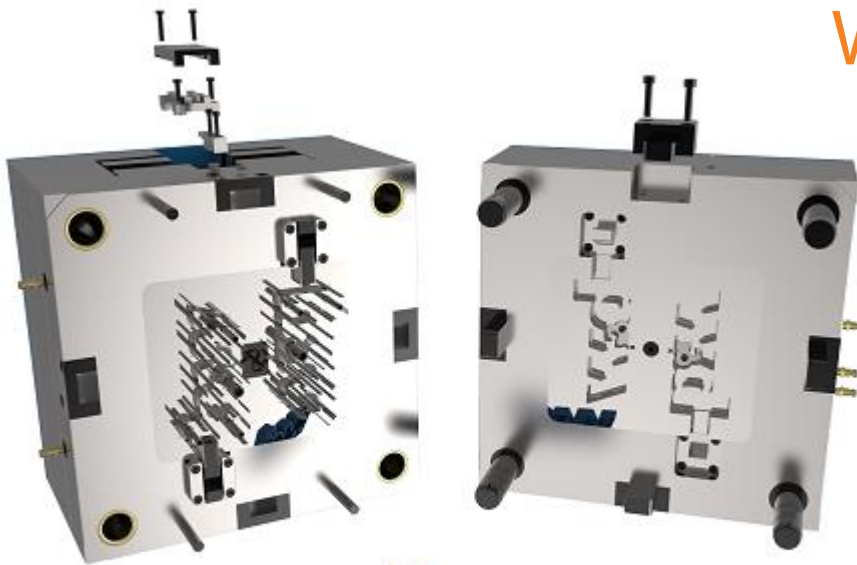

Enhancements

Compatible with new Creo 9.0.0.0