

EMX 11.0.1.2

What's New?

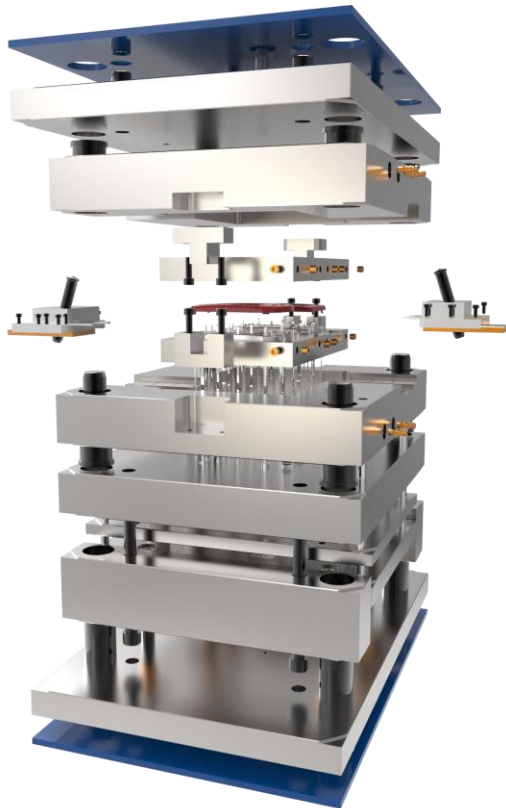

EMX 11.0.1.1

What's New?

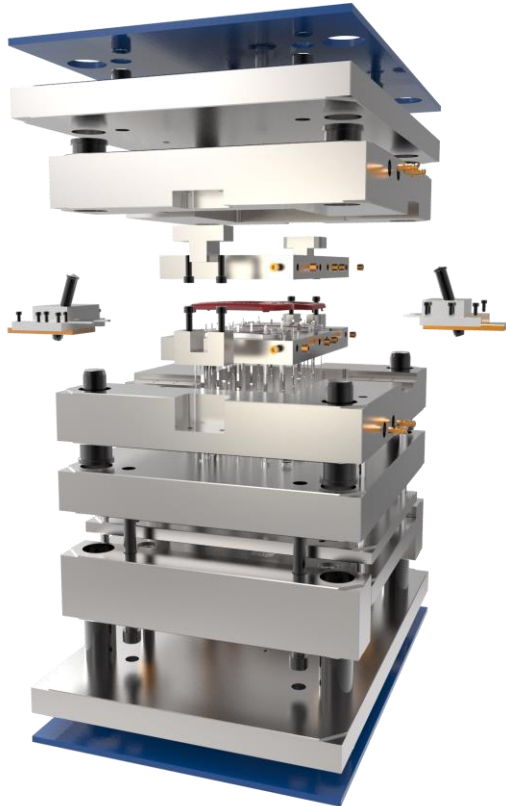

Enhancements

“Use One Model Rail” can be modified from Rail Plate Dialog

- The EMX Option USE_ONE_MODEL_RAIL only sets the default for check button
- Different types of rail models can be assembled to one mold base

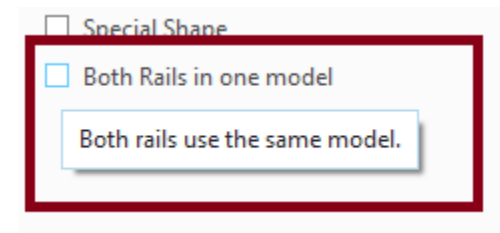
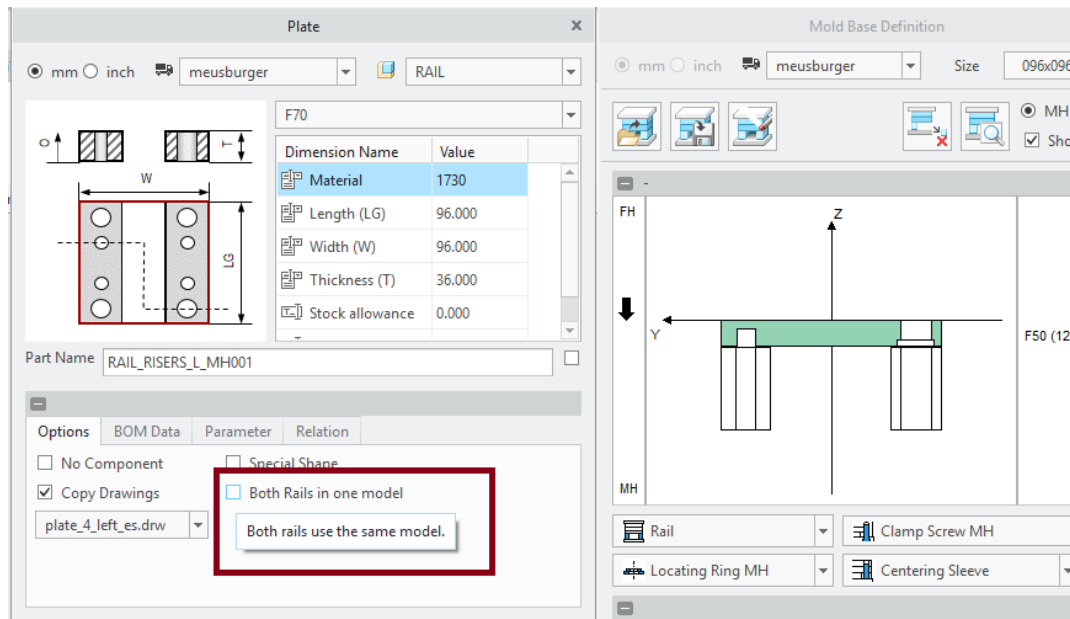

Enhancements

Unicode characters are supported for file names, parameter names and parameter values.

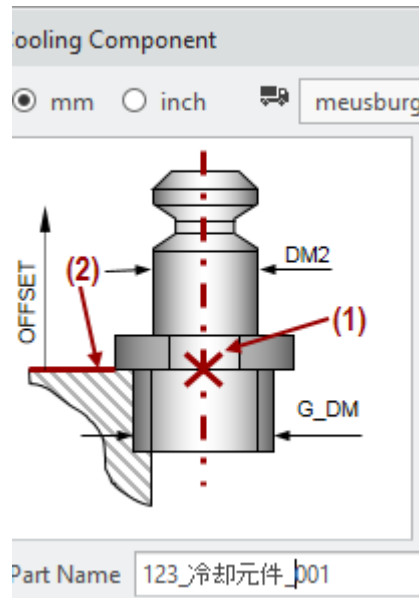
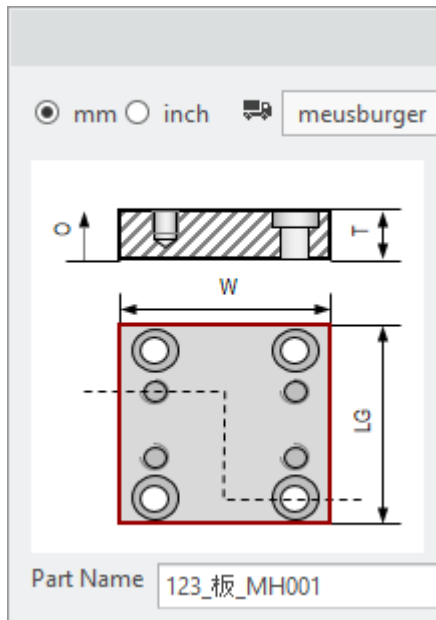
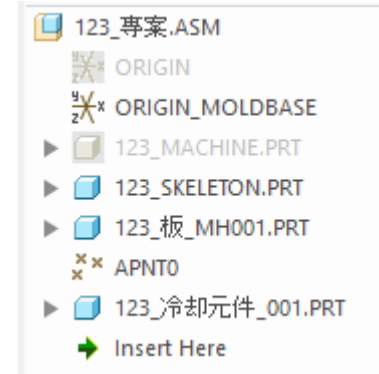

Enhancements

In BOM Dialog use UP and DOWN arrow keys to jump to next cell at top or bottom.

- Reduces clicks when working in the BOM
- Current cell value is confirmed and next cell is activated

PARTID	BOM_NAME	S
01-0001	Aufspannplatte Auswerferseite	M
01-0001	Auswerferplatte Auswerferseite	M
01-0001	Auswerferplatte Auswerferseite	M
01-0001	Leiste Auswerferseite	M
01-0001	Leiste Auswerferseite	M
01-0001	Zwischenplatte Auswerferseite	M
01-0001	Rahmenplatte Auswerferseite	M
01-0001	Rahmenplatte Duesenseite	M
01-0001	Leiste Duesenseite	M
01-0001	Leiste Duesenseite	M
01-0002	Aufspannplatte Duesenseite	M
01-0001	Auswerferplatte Duesenseite	M
01-0001	Auswerferplatte Duesenseite	M



01-0001	Auswerferplatte Auswerferseite	I
01-0001	Leiste Auswerferseite	I
01-0001	Leiste Auswerferseite	I
01-0001	Zwischenplatte Auswerferseite	I
01-0001	Rahmenplatte Auswerferseite	I

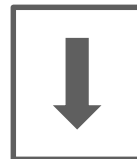

01-0001	Auswerferplatte Auswerferseite	I
01-0001	Leiste Auswerferseite	I
01-0001	Leiste Auswerferseite	I
01-0001	Zwischenplatte Auswerferseite	I
01-0001	Rahmenplatte Auswerferseite	I

Enhancements

New button in Component Dialog to reset saved component instances to default.

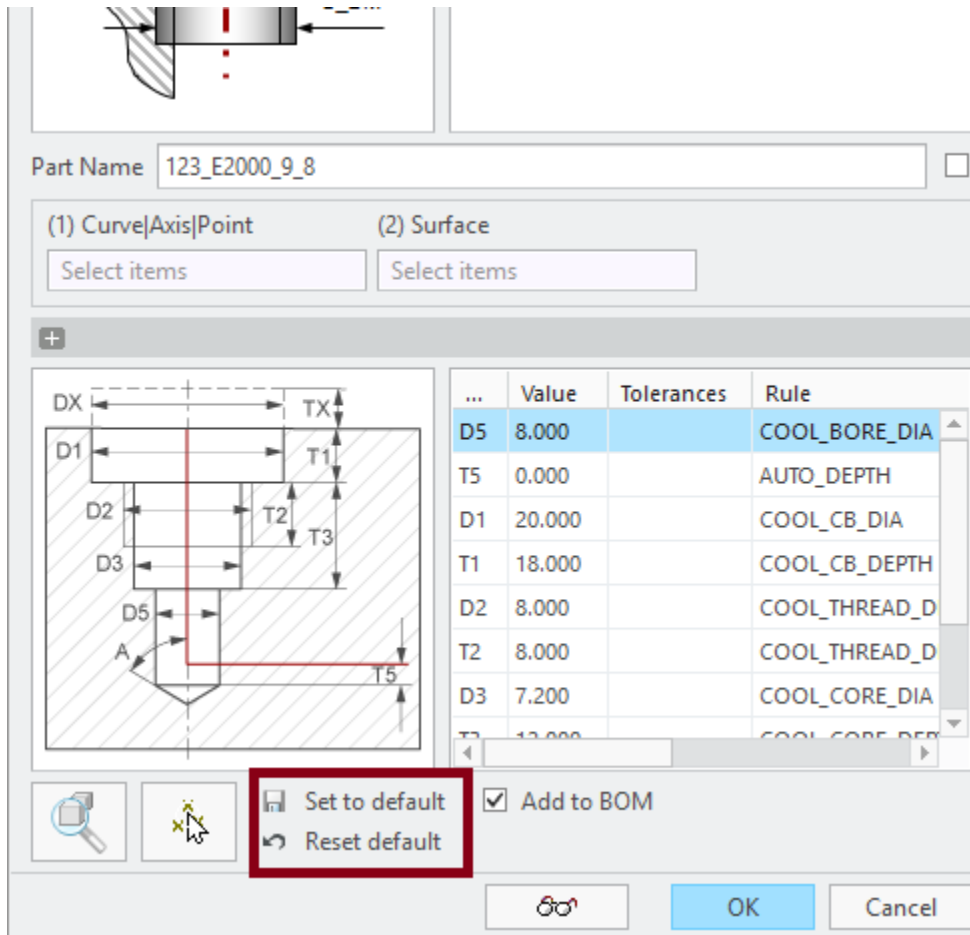

Part Name: 123_E2000_9_8

(1) Curve|Axis|Point (2) Surface

Select items Select items

...	Value	Tolerances	Rule
D5	8.000		COOL_BORE_DIA
T5	0.000		AUTO_DEPTH
D1	20.000		COOL_CB_DIA
T1	18.000		COOL_CB_DEPTH
D2	8.000		COOL_THREAD_D
T2	8.000		COOL_THREAD_D
D3	7.200		COOL_CORE_DIA
T3	12.000		COOL_CORE_DEPTH

Set to default
 Reset default

Add to BOM

OK Cancel

Enhancements

Ejector pins defined on multi point features can be forced to be created as individual models.

- Previously option ENABLE_MULTI_EJP behavior in EMX Options
- The EMX Option ENABLE_MULTI_EJP only the sets default for check button

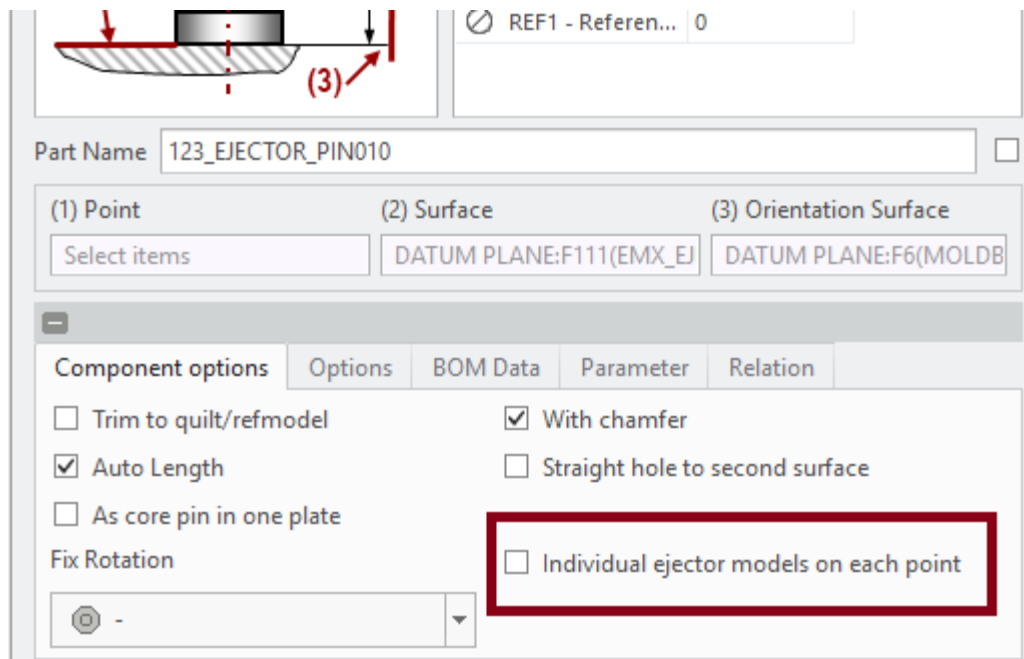

Components

New components

- MEUSBURGER cooling components E20749 and E2074D.

EMX 11.0.1.0

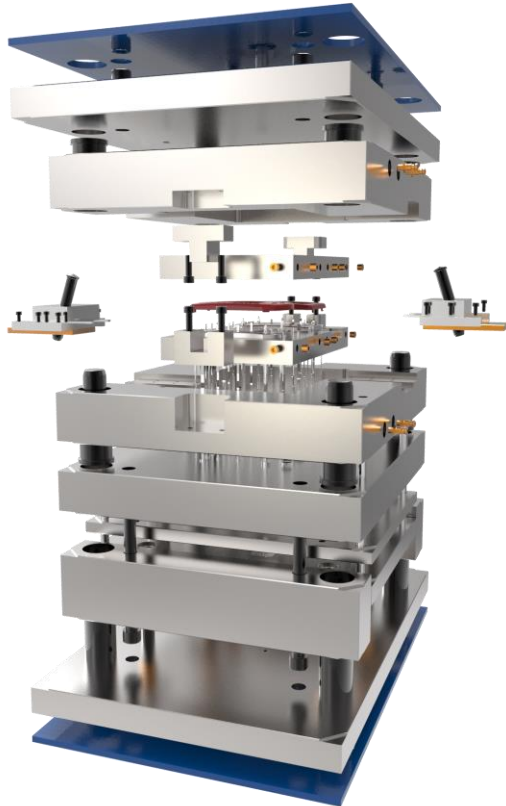

What's New?

- Enhancements
- Components

Enhancements

Enable Mini Tool Bar with EMX 10 and Creo 4.0

- Select Datum Points and Axis
- Create Components by Mini Tool bar commands
- Selection of selected datums is immediately stored in Component Dialog

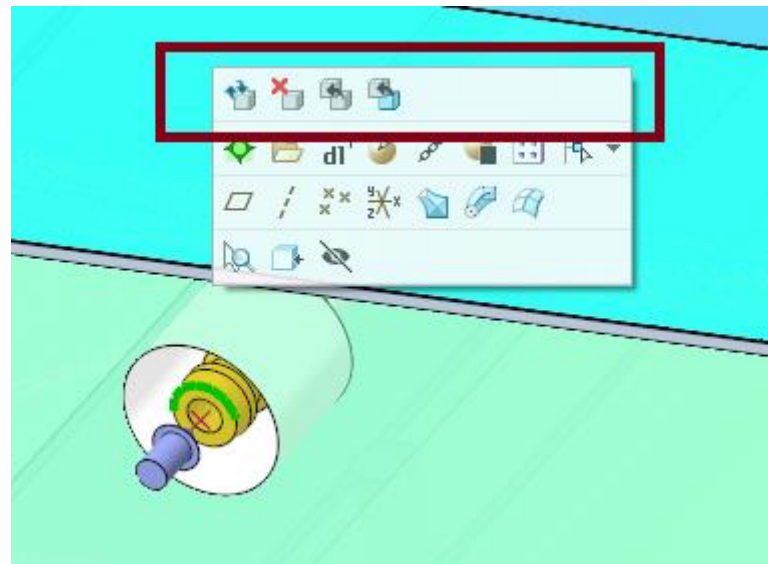
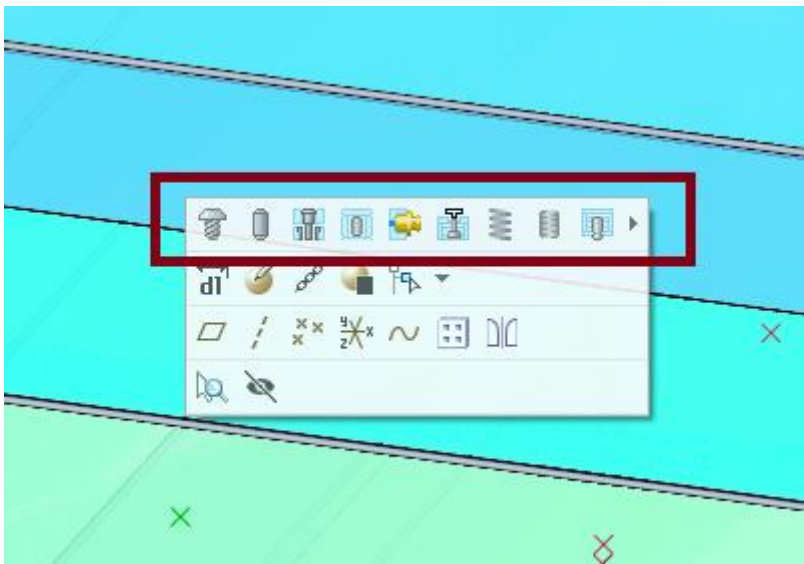

Enhancements

Improve Ejector UDFs and Options

- New Rotation Fixture Type
- New Chamfer Option
- Visualization of Trim Option
- Separate Rotation Fixture Angle for all UDF Types
- Improved Preview Sketch UDFs
- Separate Tabs for Component Options and Assembly Options

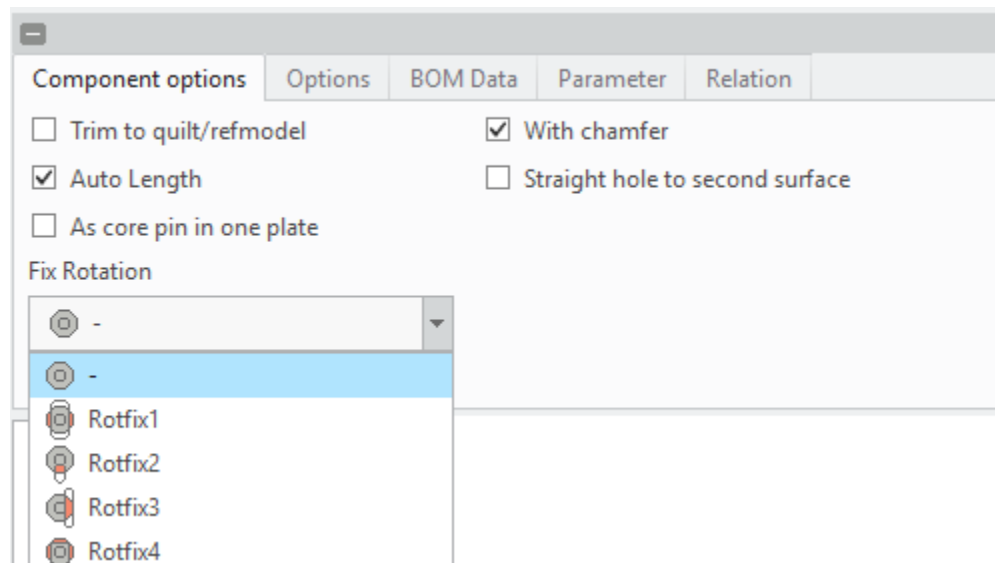

Enhancements

New UDF Images for Cooling Components, Guides, Ejector Pins and Dowel Pins

- Verification of all visualized UDF dimensions
- New Design

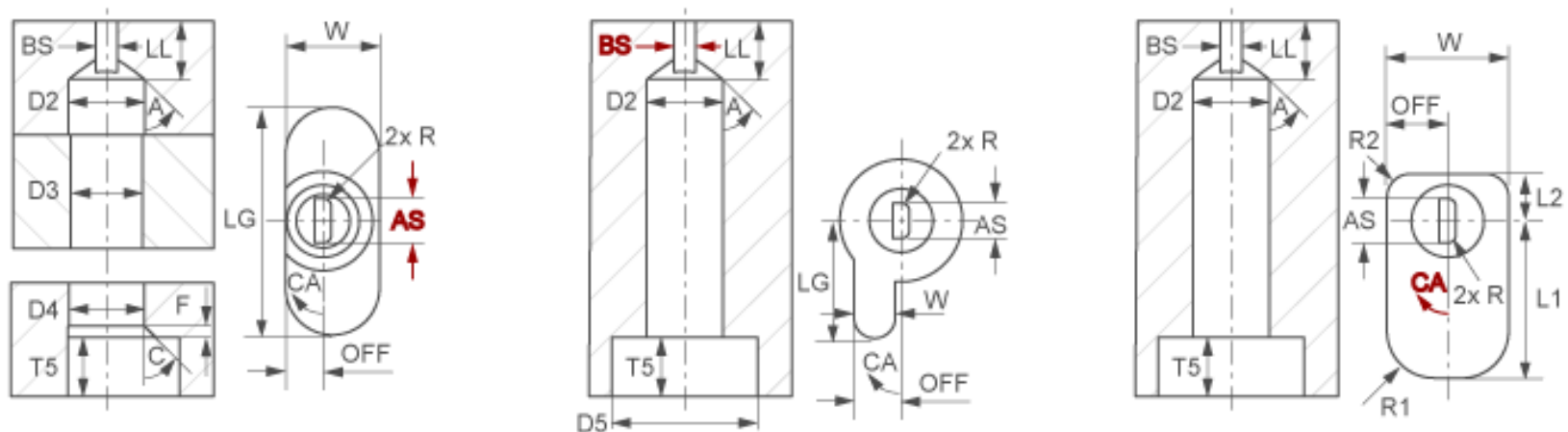

Enhancements

New Feature Visibility Status Type “Visible Locked” in Plate Dialog

- Feature can be resumed and locked.
- It will not be suppressed when changing the size of the plate

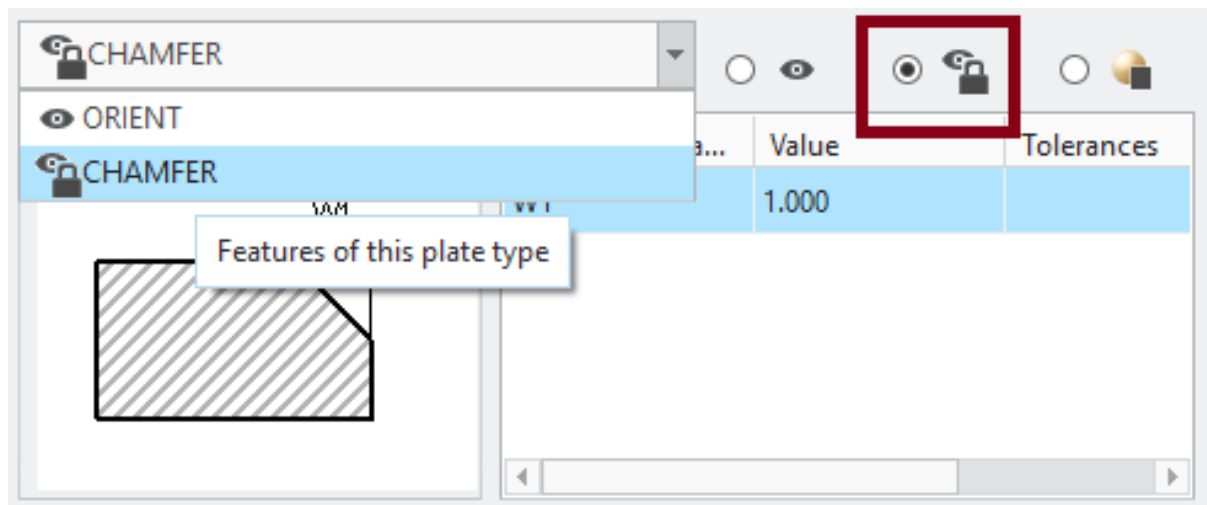

Components

STRACK

- Update of existing ejectors
- New Springs: SN2520, SN2540, SN3560, SN3580, SN2590, SN2600, SN2625
- New Side Interlocks: W44, Z38,Z46

EBERHARD

- Update of existing ejectors
- New Ejectors: 6116, 6118, 612R, 6143, 6178, 6261, 6271, 6281, 6331, 6335, 6341, 6351, 6361, 6371, 6381, 6441, 6622

MEUSBURGER

- Update component and plate data to latest state

LKM

- Clamping Slots available for side gate plates

KNARR

- Update component data to latest state
- 
- A decorative curved line in the bottom right corner, consisting of a grey outer curve and an orange inner curve.