

EMX 10 M022

What's New?

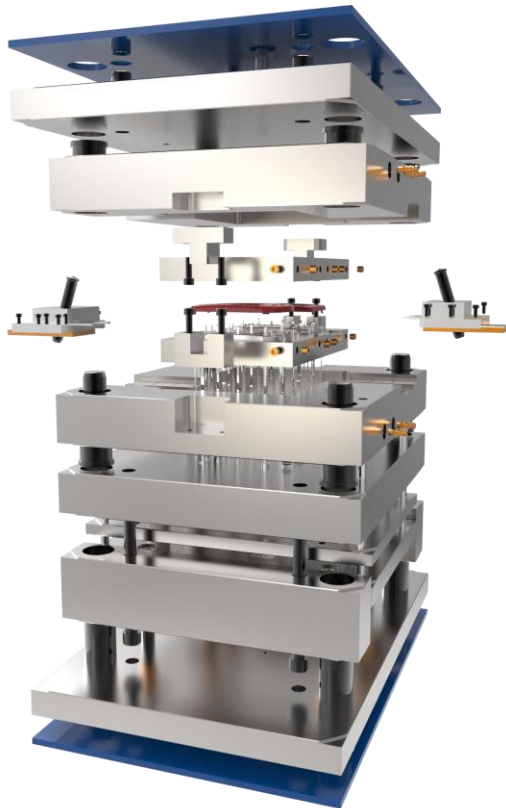

EMX 10 M021

What's New?

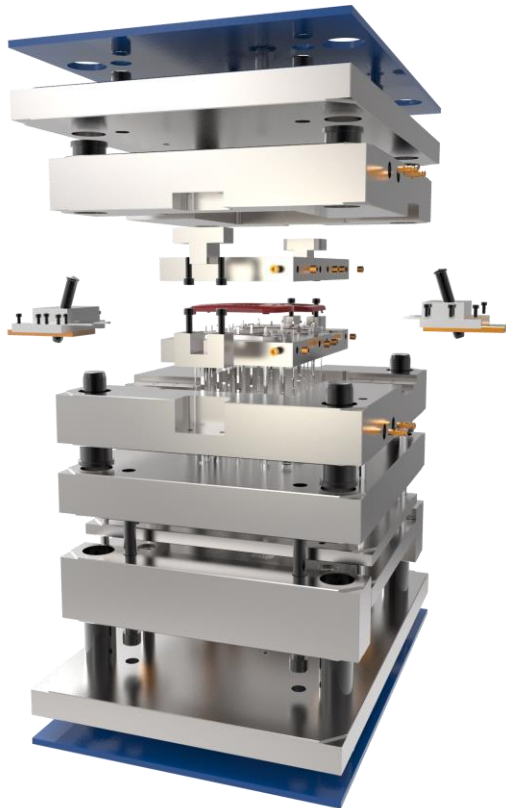

Enhancements

“Use One Model Rail” can be modified from Rail Plate Dialog

- The EMX Option USE_ONE_MODEL_RAIL only sets the default for check button
- Different types of rail models can be assembled to one mold base

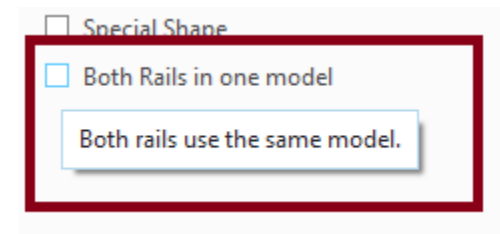
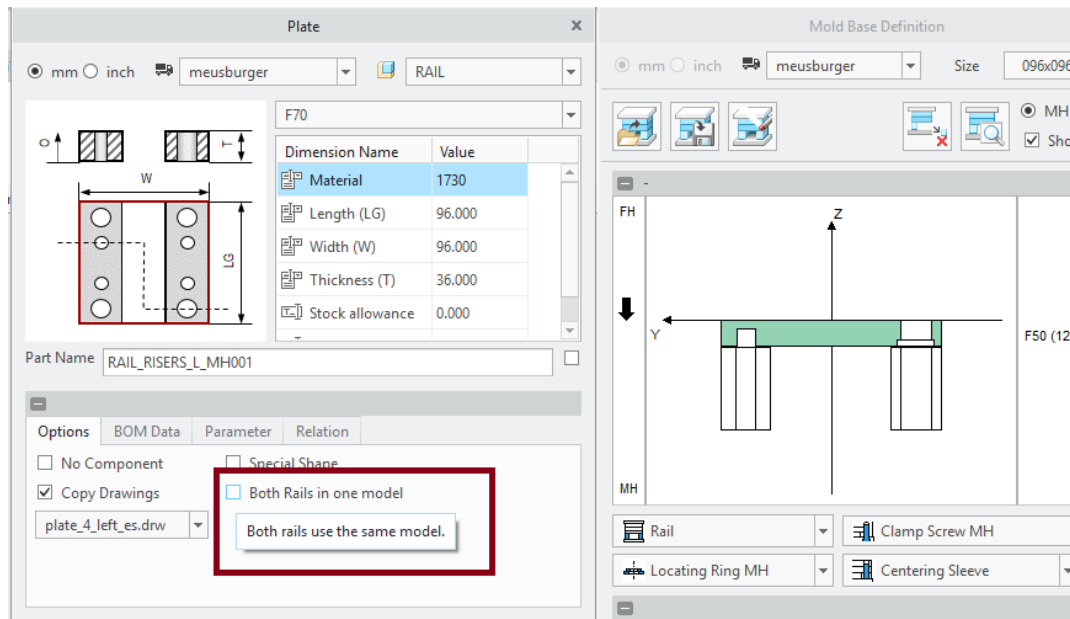

Enhancements

Unicode characters are supported for file names, parameter names and parameter values.

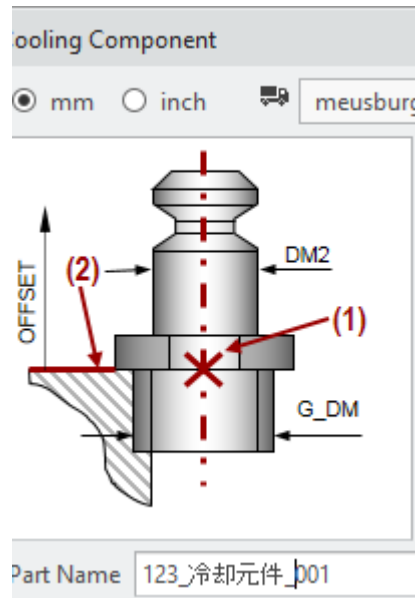
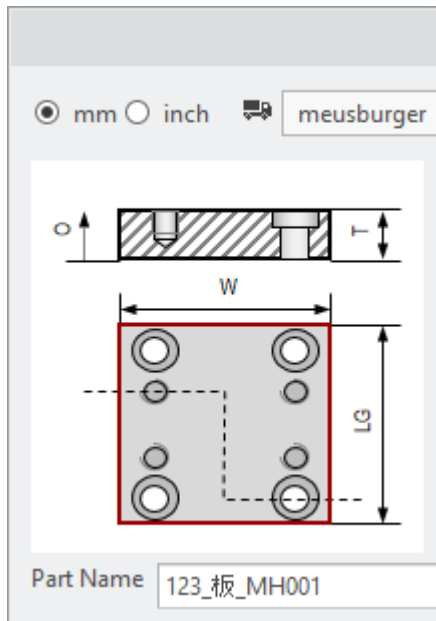
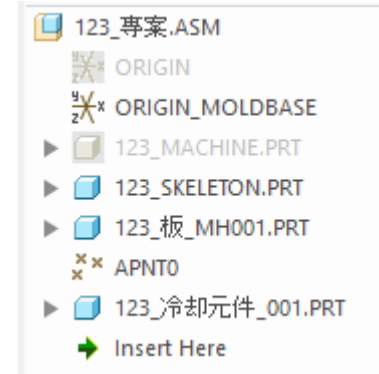

Enhancements

In BOM Dialog use UP and DOWN arrow keys to jump to next cell at top or bottom.

- Reduces clicks when working in the BOM
- Current cell value is confirmed and next cell is activated

PARTID	BOM_NAME	S
01-0001	Aufspannplatte Auswerferseite	M
01-0001	Auswerfergplatte Auswerferse...	M
01-0001	Auswerferplatte Auswerferseite	M
01-0001	Leiste Auswerferseite	M
01-0001	Leiste Auswerferseite	M
01-0001	Zwischenplatte Auswerferseite	M
01-0001	Rahmenplatte Auswerferseite	M
01-0001	Rahmenplatte Duesenseite	M
01-0001	Leiste Duesenseite	M
01-0001	Leiste Duesenseite	M
01-0002	Aufspannplatte Duesenseite	M
01-0001	Auswerfergplatte Duesenseite	M
01-0001	Auswerferplatte Duesenseite	M



01-0001	Auswerferplatte Auswerferseite	I
01-0001	Leiste Auswerferseite	I
01-0001	Leiste Auswerferseite	I
01-0001	Zwischenplatte Auswerferseite	I
01-0001	Rahmenplatte Auswerferseite	I



01-0001	Auswerferplatte Auswerferseite	I
01-0001	Leiste Auswerferseite	I
01-0001	Leiste Auswerferseite	I
01-0001	Zwischenplatte Auswerferseite	I
01-0001	Rahmenplatte Auswerferseite	I

Enhancements

New button in Component Dialog to reset saved component instances to default.

Part Name: 123_E2000_9_8

(1) Curve|Axis|Point (2) Surface

Select items Select items

...	Value	Tolerances	Rule
D5	8.000		COOL_BORE_DIA
T5	0.000		AUTO_DEPTH
D1	20.000		COOL_CB_DIA
T1	18.000		COOL_CB_DEPTH
D2	8.000		COOL_THREAD_D
T2	8.000		COOL_THREAD_D
D3	7.200		COOL_CORE_DIA
T3	12.000		COOL_CORE_DEPTH

Set to default
 Reset default

Add to BOM

OK Cancel

Enhancements

Ejector pins defined on multi point features can be forced to be created as individual models.

- Previously option ENABLE_MULTI_EJP behavior in EMX Options
- The EMX Option ENABLE_MULTI_EJP only the sets default for check button

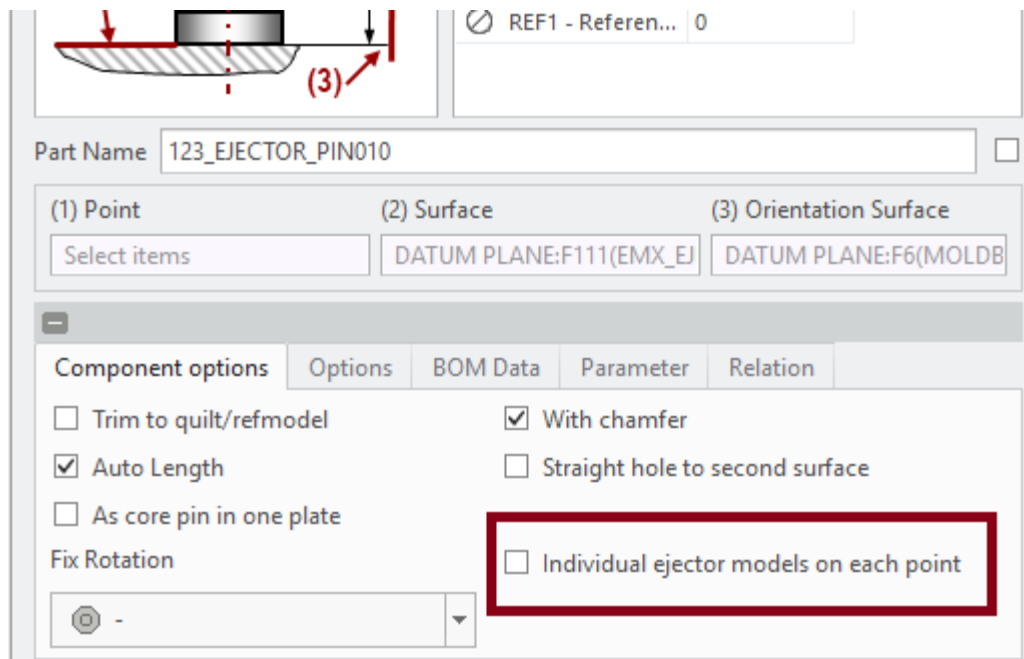

Components

New components

- MEUSBURGER cooling components E20749 and E2074D.

EMX 10 M020

What's New?

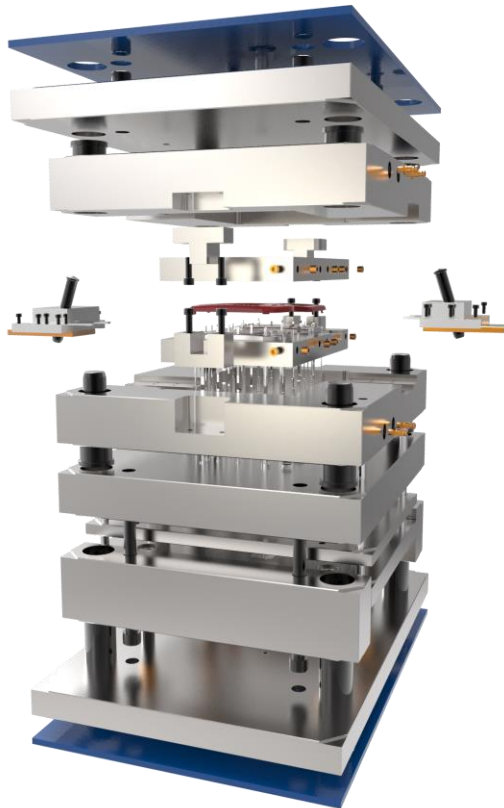

Enhancements

Enable Mini Tool Bar with EMX 10 and Creo 4.0

- Select Datum Points and Axis
- Create Components by Mini Tool bar commands
- Selection of selected datums is immediately stored in Component Dialog

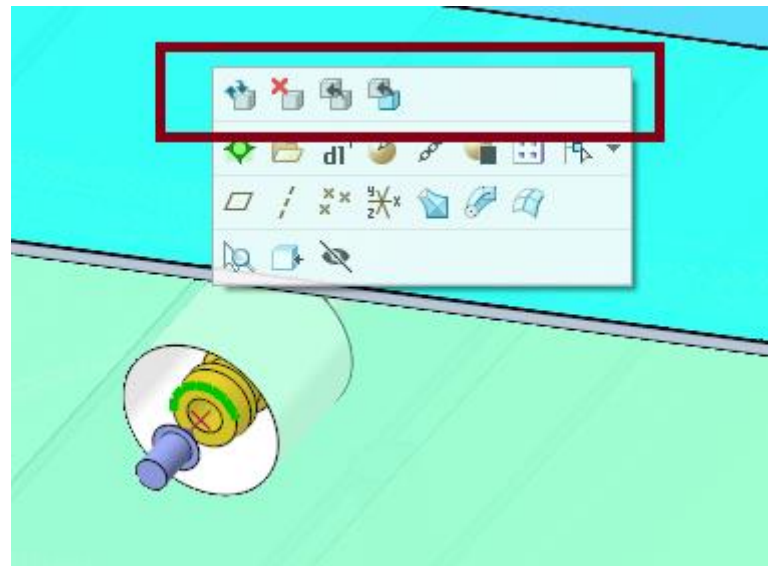
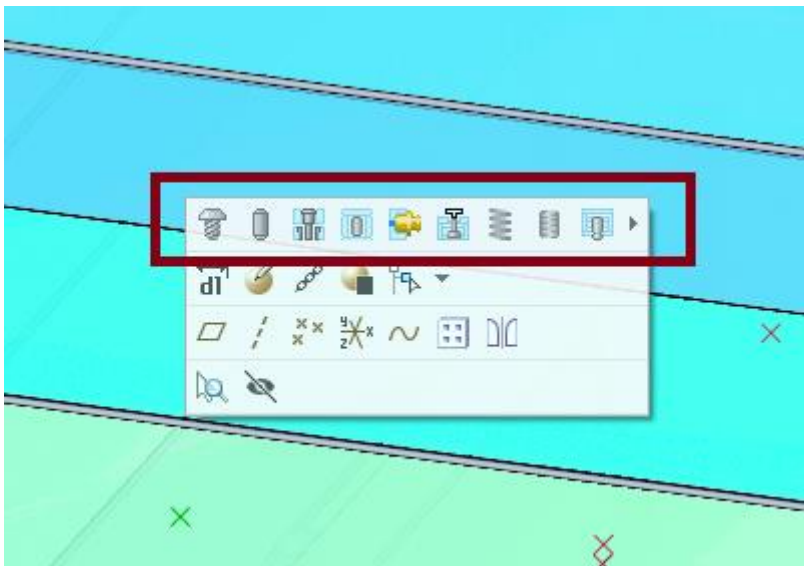

Enhancements

Improve Ejector UDFs and Options

- New Rotation Fixture Type
- New Chamfer Option
- Visualization of Trim Option
- Separate Rotation Fixture Angle for all UDF Types
- Improved Preview Sketch UDFs
- Separate Tabs for Component Options and Assembly Options

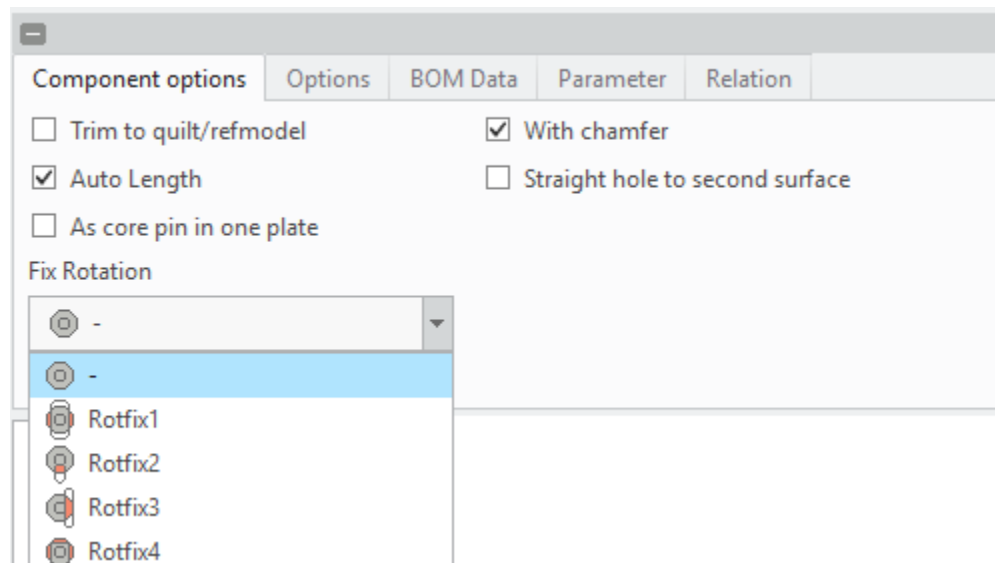

Enhancements

New UDF Images for Cooling Components, Guides, Ejector Pins and Dowel Pins

- Verification of all visualized UDF dimensions
- New Design

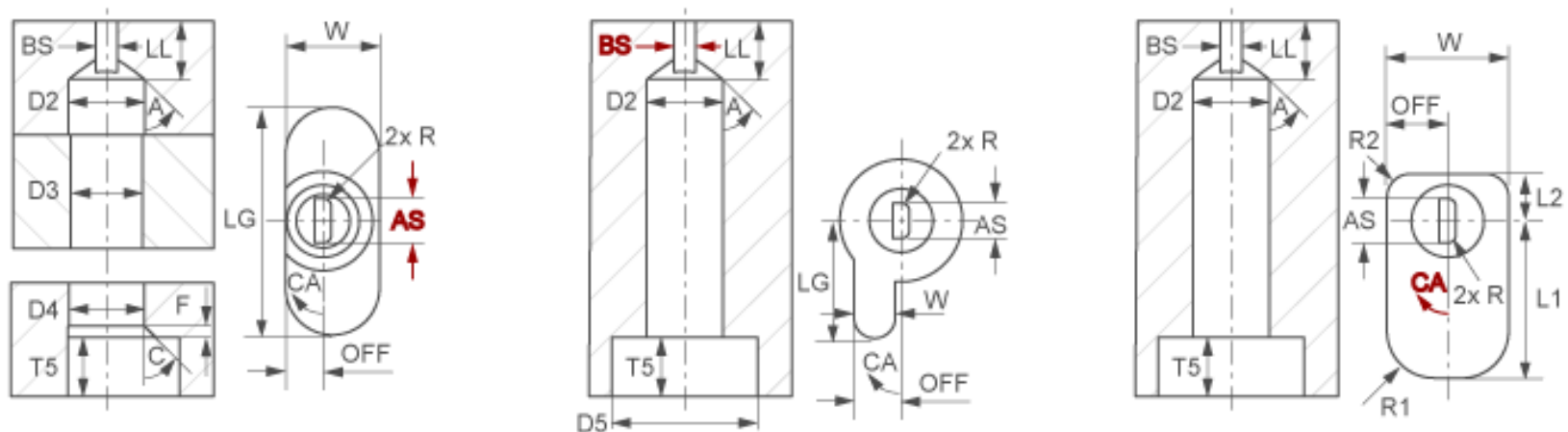

Enhancements

New Feature Visibility Status Type “Visible Locked” in Plate Dialog

- Feature can be resumed and locked.
- It will not be suppressed when changing the size of the plate

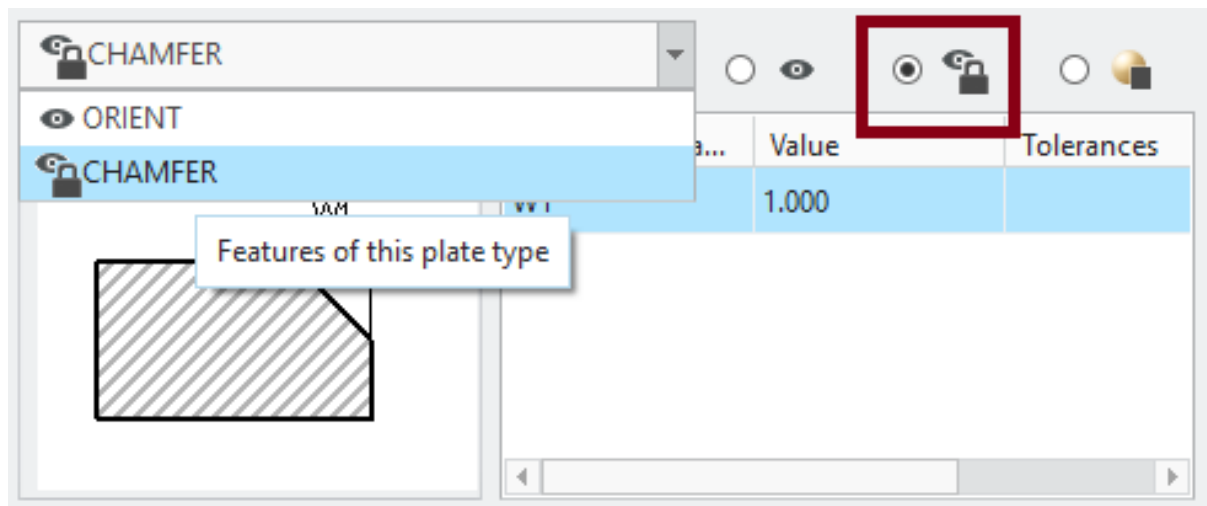

Components

STRACK

- Update of existing ejectors
- New Springs: SN2520, SN2540, SN3560, SN3580, SN2590, SN2600, SN2625
- New Side Interlocks: W44, Z38,Z46

EBERHARD

- Update of existing ejectors
- New Ejectors: 6116, 6118, 612R, 6143, 6178, 6261, 6271, 6281, 6331, 6335, 6341, 6351, 6361, 6371, 6381, 6441, 6622

MEUSBURGER

- Update component and plate data to latest state

LKM

- Clamping Slots available for side gate plates

KNARR

- Update component data to latest state
- 
- A decorative curved line in the bottom right corner, consisting of a grey outer curve and an orange inner curve.

EMX 10 M013

What's New?

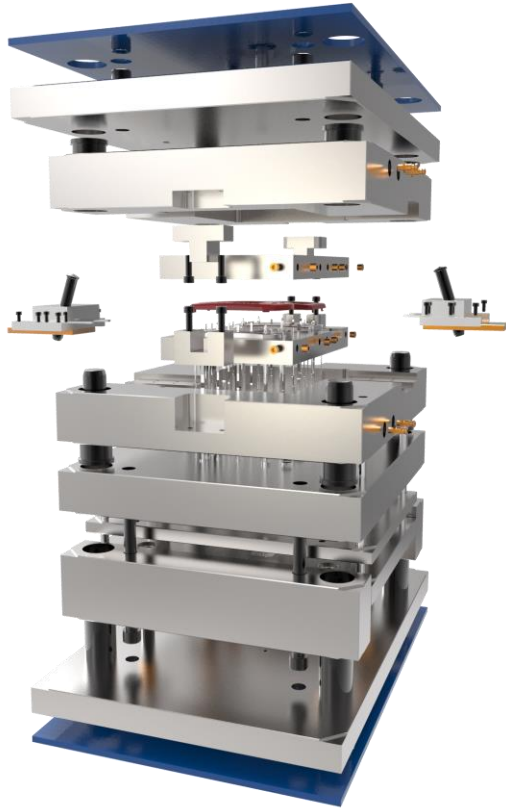

Components

Side Interlock

- Strack Z38, Z46, W44

Top Interlock

- Agathon 7992, 7993
- Meusbürger E1311

Library

- Hasco Z67 (Circlip)

Screw

- Hasco Z715, Z725 (Hoisting)

Guide

- Hasco Z016, Z025

Ejector Pins

- Hasco Z400, Z410, Z492, Z4655, Z4656
- 
- A decorative curved line in the bottom right corner, consisting of a grey outer curve and an orange inner curve.

Components

Updated Instances

- HASCO guide components Z011, Z012, Z013 and Z022.
- HASCO screw Z31 and Z32.
- HASCO ejectors Z40, Z41 and Z42.

EMX 10 M012

What's New?

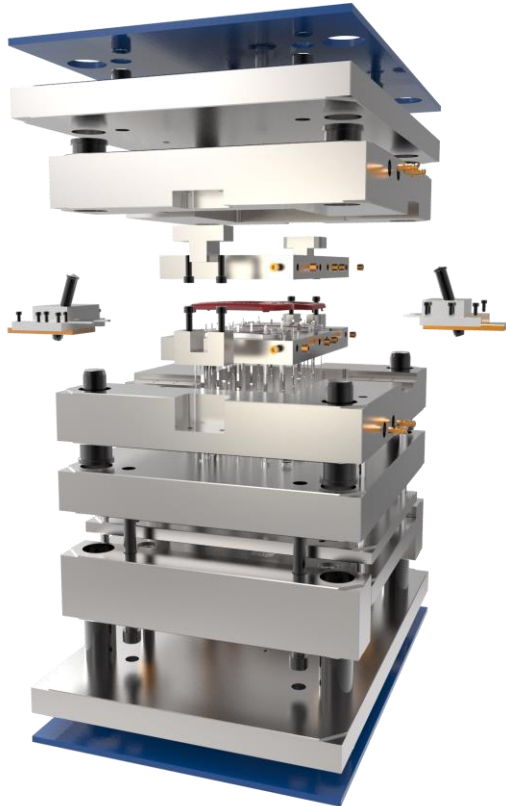

Enhancements

Export waterline curves for Moldflow analysis

- New option in “Show Waterline” feature
- Curves of waterline circuits are created when option is enabled

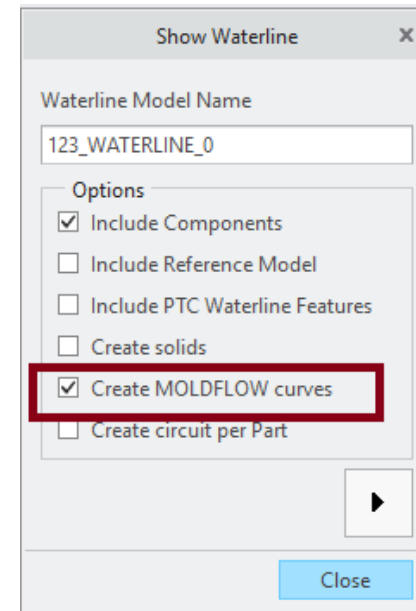
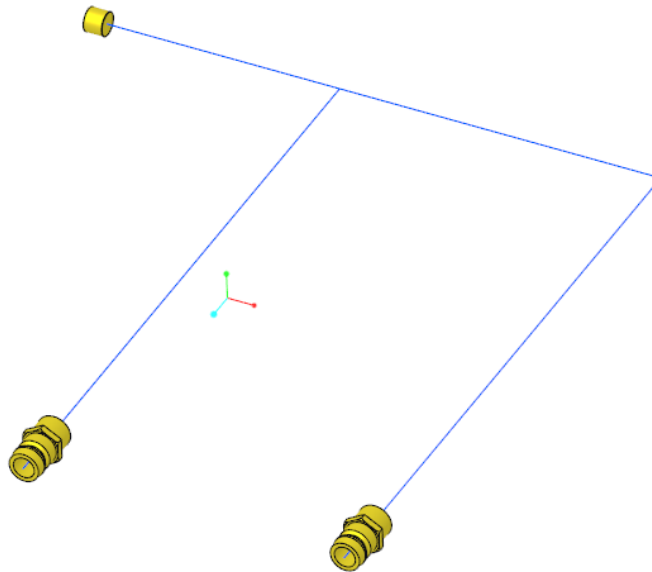

Enhancements

New Option: INCLUDE_EJECTOR_BORES_IN_MOLD_ANALYSIS

- All bores created by EMX ejectors are tagged with parameter
- When using wall thickness check in Tool Design, ejector bores are considered as well.

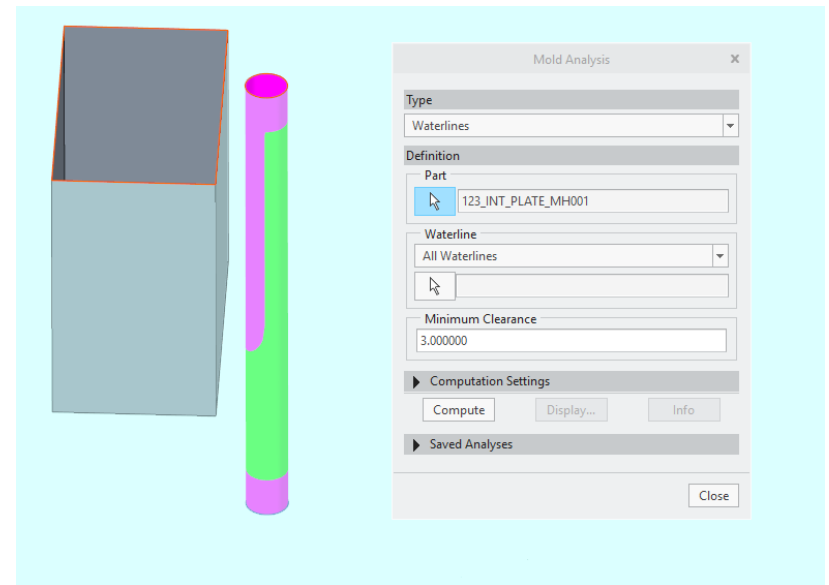
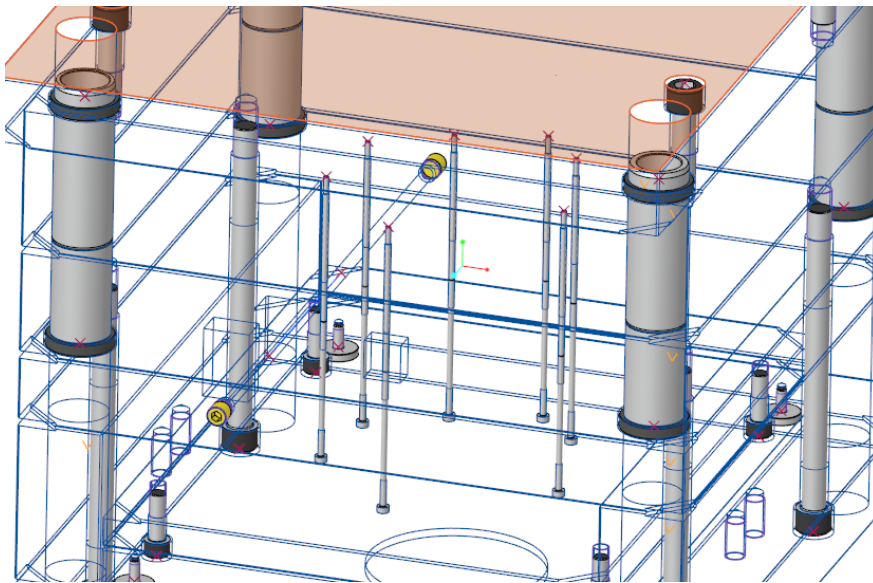

Enhancements

Library components can be placed with Component Interface

- Prepare library parts with Creo component interface
- Example can be found:

<emx_install> \mm\library\demo\example_comp_interface

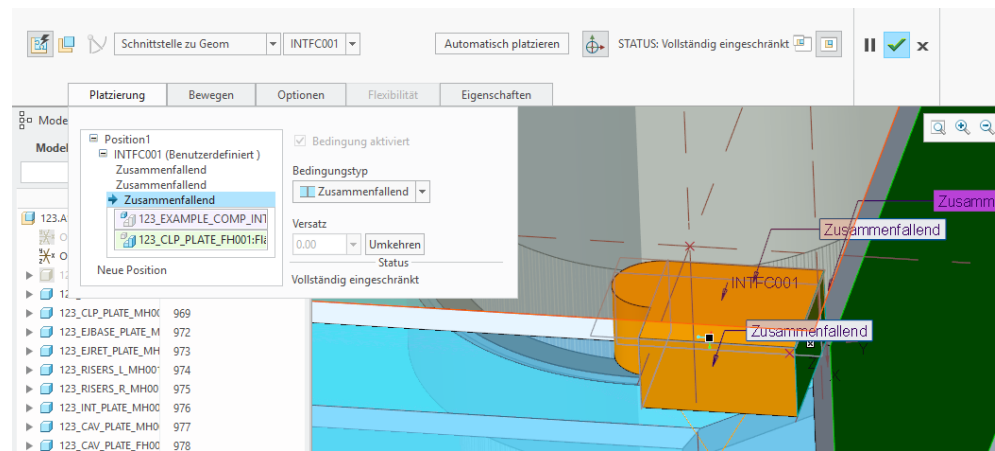
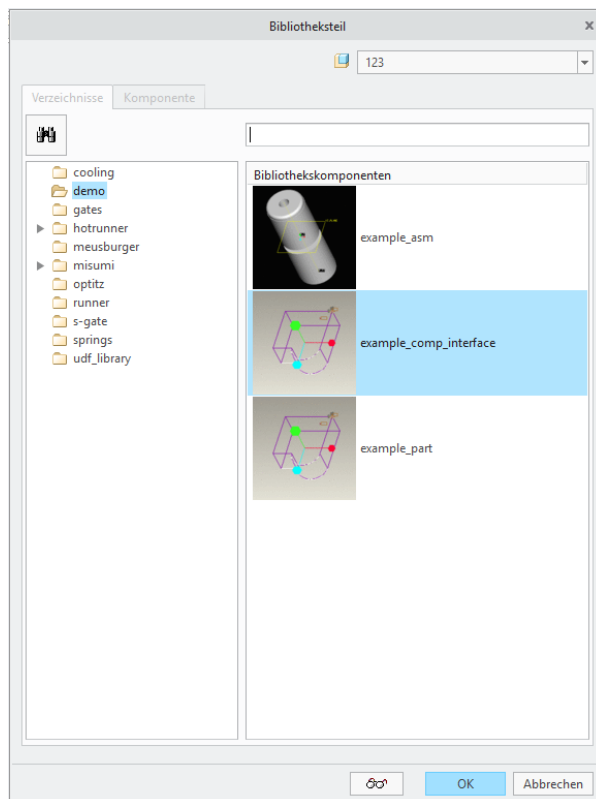

Enhancements

Improve behavior when standard parts are retrieved from Windchill or “search_path” folder.

- When standard part is found in Windchill or search_path folder and active option PDM_SYSTEM is used source status is displayed in Component Dialog.

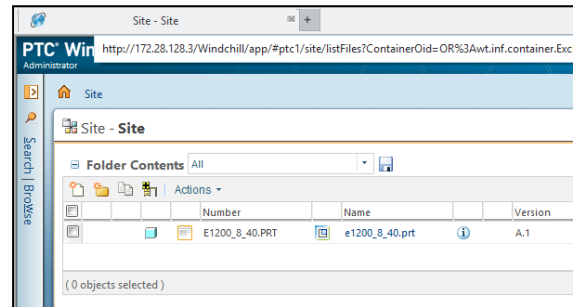
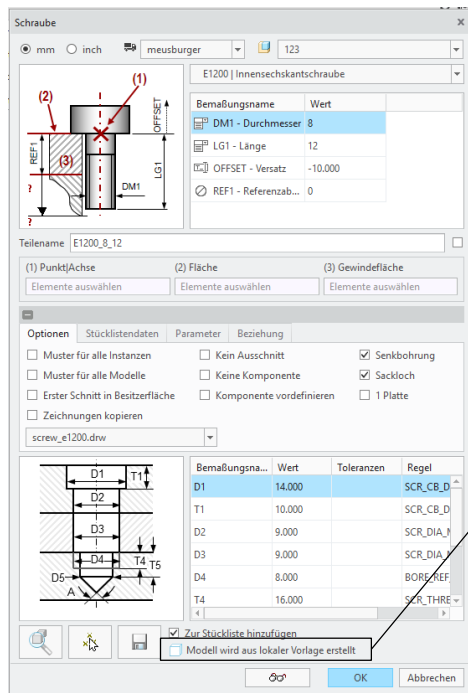

Modell wird aus lokaler Vorlage erstellt

Modell im Commonspace gefunden

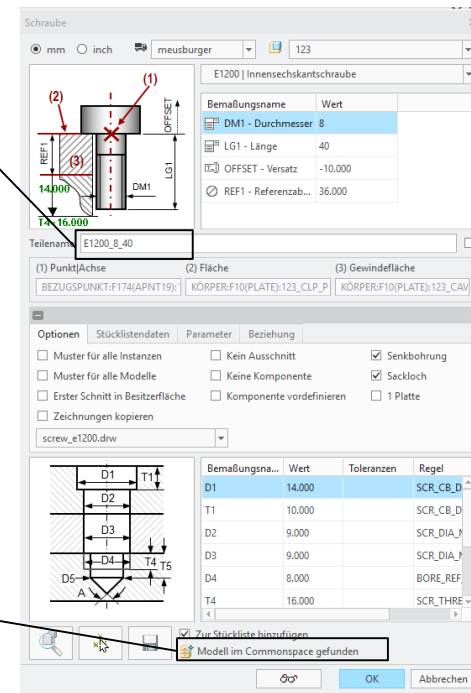

Enhancements

New Button in Ejector Pin Designer: Placement of ejector pins on existing points (Sketched points or multiple points features)

- Existing Points can be selected. Multi point features are supported.
- Ejector Pin Designer assembles multiple ejectors in one step
- All advantages of parametric sketches.

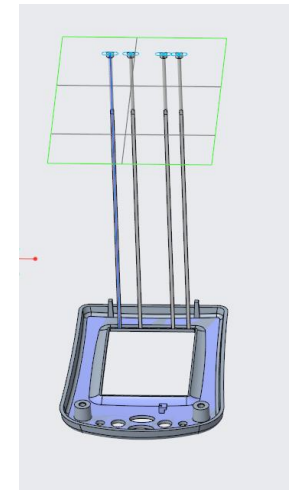
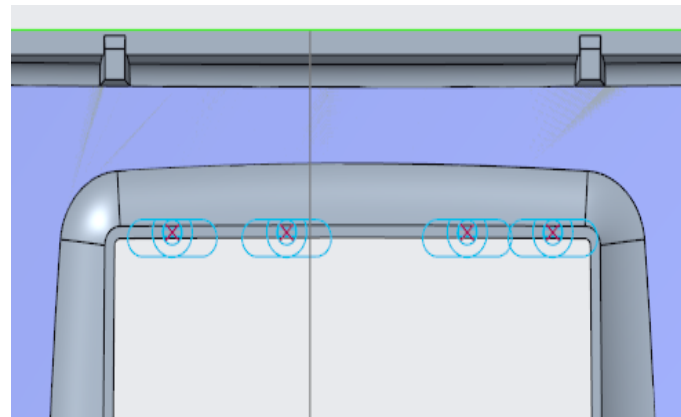
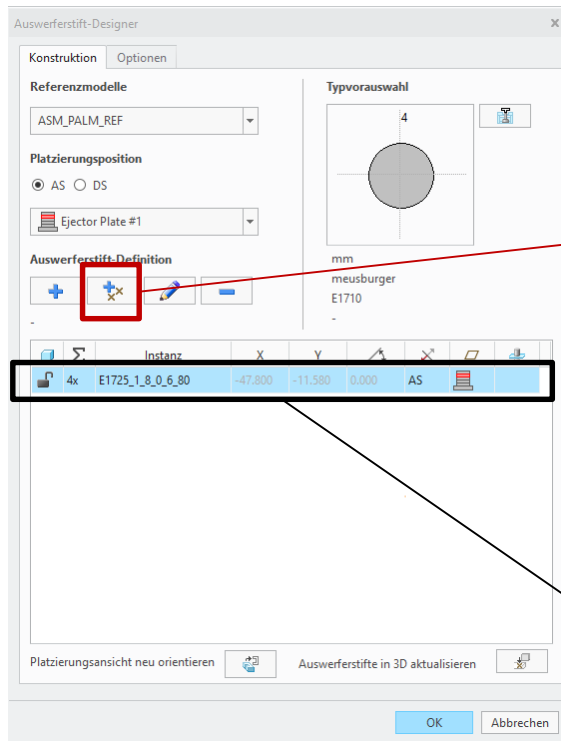

🔒	4x	E1725_1_8_0_6_80	-47.800	18.193	0.000	AS	📄
---	----	------------------	---------	--------	-------	----	---

Components

Top Interlock

- AGATHON 7990

EMX 10 M011

What's New?

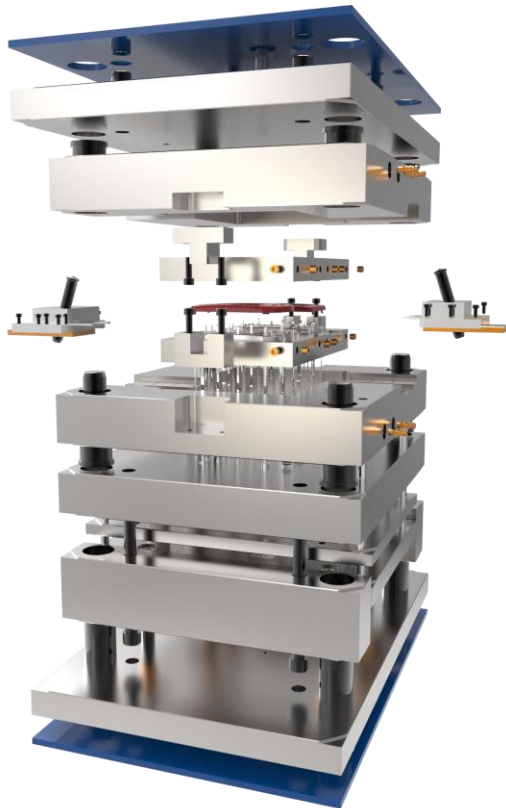

New Components

Compact slider sets

- Meusburger E3080 with E3082/E3084
- Meusburger E3072 with E3074/E3076/E3078
- Meusburger E3070 with E3074/E3076/E3078
- Meusburger E3360
- Meusburger E3330
- Meusburger E3300
- Meusburger E3045, E3047, E3048 and E3049 – locking for slider
- Meusburger E30110 - slider set

Library Components

- Meusburger E2730 - Cable box as library component
 - Meusburger E2682 - Distance plate round
 - Meusburger E2680 - Distance plate rectangular
 - Optiz DATI1000, DATI2000, DATI2900 and DATI3000 - date stamps
- 
- A decorative curved line in the bottom right corner, consisting of a grey outer curve and an orange inner curve.

New Components

Guides

- Meusburger E1064 - Guide unit for FW moldbases
- Meusburger E1115, E11202, E11206 and E1170
- Meusburger E1150 - Guide for knockouts with predefined screws

- Strack Z69, Z68, Z4315, Z4085, Z4078-R, Z4078, Z4077-R, W35, W35-R, W33, W33-R, W32, W31, W30, W25, W24, W23, W21 and W20

- Knarr 264180, 51001, 51003, 51011, 510110W, 51100, 51110, 511100W, 51112, 51113W, 51114, 51210, 51211, 51702, 51711, 51712, 51713, 51722, 51911, 51912, 51932, 51934 and 551110.

New Components

Support Pillars

- Meusburger E1512 and E1513
- Strack Z19

Ejectors

- Meusburger E1700DLC, E17103, E1710DLC, E17262, E17262DLC, E17264, E1727DLC, E1728DLC and E1742
- Strack - R1628, R1634, Z6015 and Z6017
- More Knarr ejectors

Dowel Pins

- Meusburger E1301
 - Strack R523
- 
- A decorative curved line in the bottom right corner, consisting of a grey outer arc and an orange inner arc.

New Components

Locating Rings

- Meusburger E1367, E1372, E1377 and E1382
- Strack Z10, Z11, Z16
- More Knarr Locating Rings

Springs

- Meusburger E1536, E15365, E1537, E15375, E1358, E15385 and E1539

Support Bush

- Meusburger E1662, E1663 and E1664

Cooling Components

- Meusburger E23.. - USA-type
 - Strack Z7714, Z7720, Z7725, Z7748 and Z7771
- 
- A decorative curved line in the bottom right corner, consisting of a thick grey arc and a thin orange arc.

New Components

Plates

- Meusburger FW and FB mold bases with plate features

Screws

- Meusburger E1225, E1226, E1251, E1252, E1274 and E1275

Top Interlock

- Meusburger E1306

Side Interlock

- Meusburger E1308, E1315 and E1320

Knockout

- Meusburger E1516 and E1517 for FW mold bases.
- 
- A decorative graphic element in the bottom right corner consisting of a thick grey curved line and a thinner orange curved line below it.

EMX 10 M010

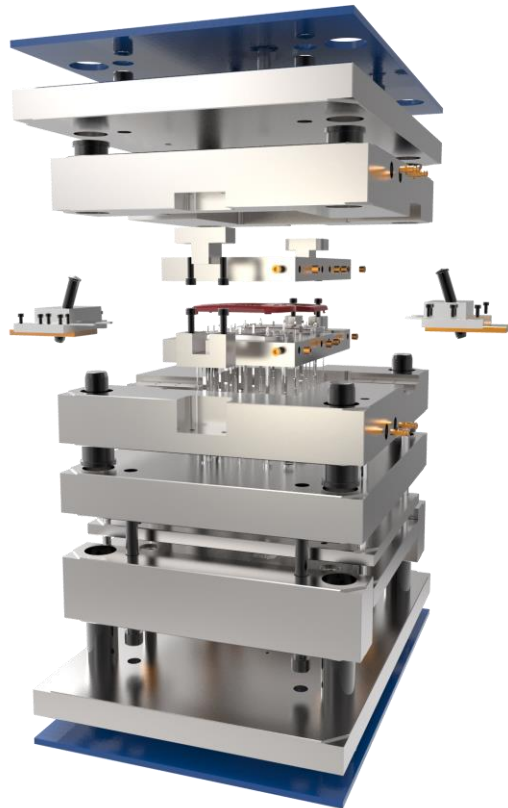

What's New?

- New Features
- Components

EMX 10 M010

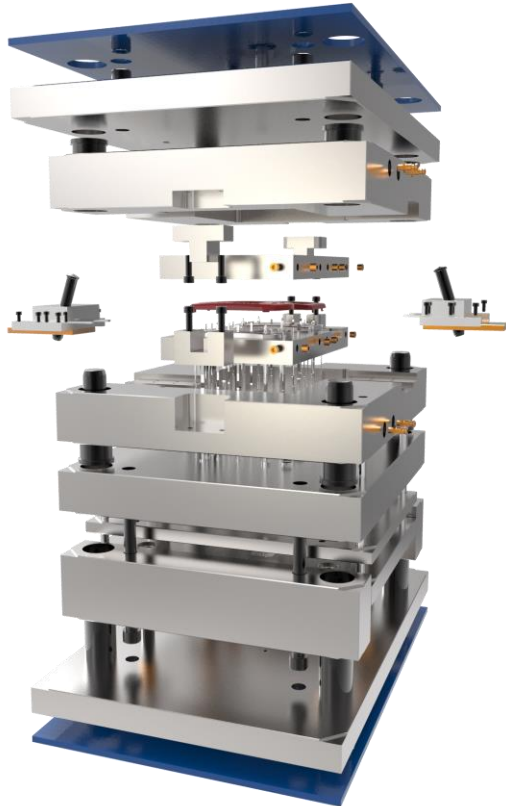

What's New?

- New Features
- Components

1. Enhanced Waterline Designer

Quick Selection of Components from Waterline List

- Predefine up to 4 default components in EMX Option

WATERLINE_DESIGNER_DEFAULT_COMPONENT mm|meusburger|E2080_8_10&&mm|meusburger|E2000_13_14&&mm|meusburger|E2130_11_8_2_4&&mm|meusburger|HOLE_8

- Use Right Mouse Button in table and assign quickly

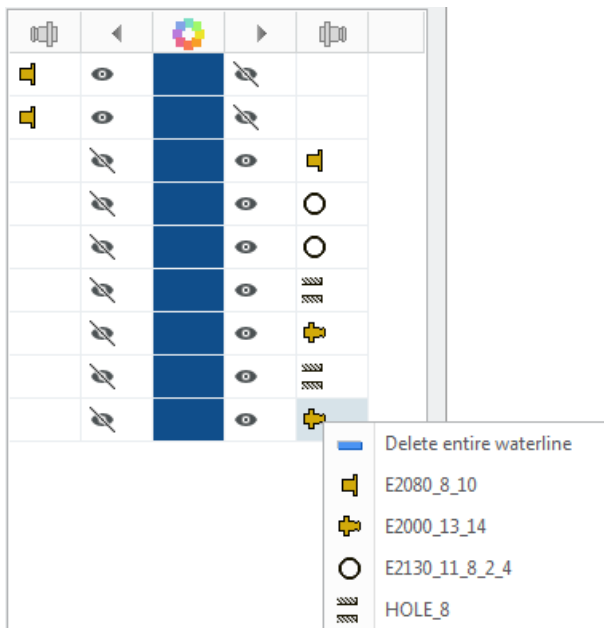

→ Design a complete cooling cooling circuit without opening the Component Dialog once!

1. Enhanced Waterline Designer

Define Waterlines on Existing Curves

(Only with B&W Direct License)

- Use existing curves in sketches as waterline reference
- New button → Select curves in current working model

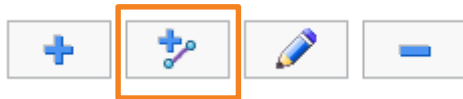

- Vertical waterlines will be attached to the existing curves and updated parametrically when sketch is modified

→ Benefit from parametric sketches and easy definition of cooling circuits

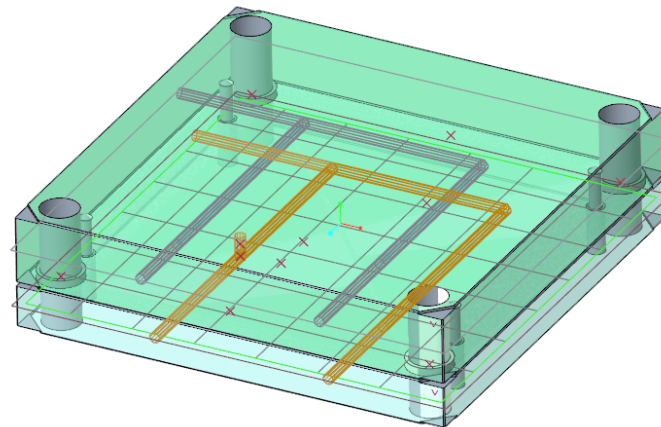

2. Toggle Wireframe Style

Fast Toggle of Wireframe Style from the Ribbon
(Only with B&W Direct License)

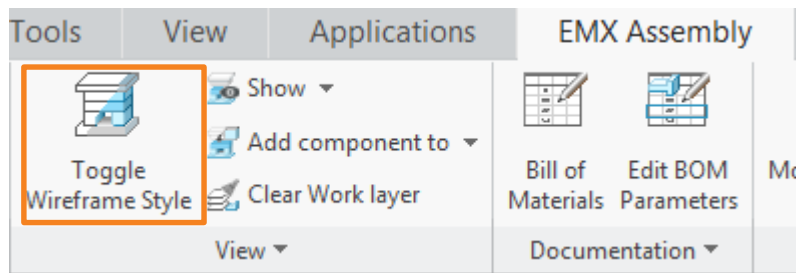

No need to open the View Manager anymore

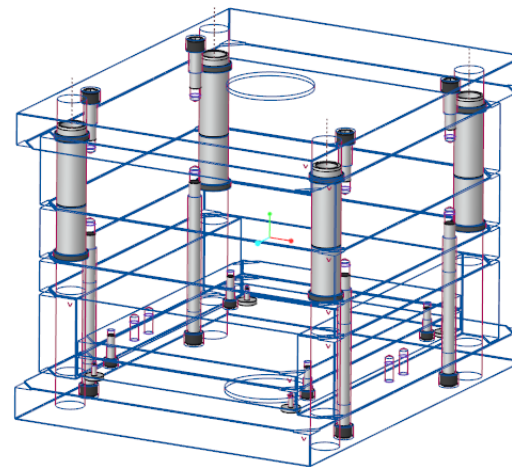
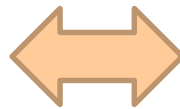
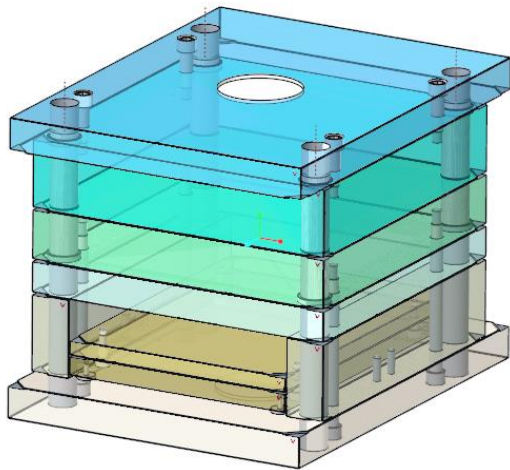

3. New Rule-Based Layer Concept

New Option `USE_RULEBASED_LAYER_CONCEPT`

- Layers are copied from template files in folder “configuration\templates\rules_layers.prt/asm”

- Layer concept is completely customizable
 - Layers are not created by the software anymore
 - No more hardcoded layer names
 - Combined states and simplified representation are used to visualize datums and solids
 - WORK layer only shows recently created datums
- Avoids confusion with tons of datums in large assemblies

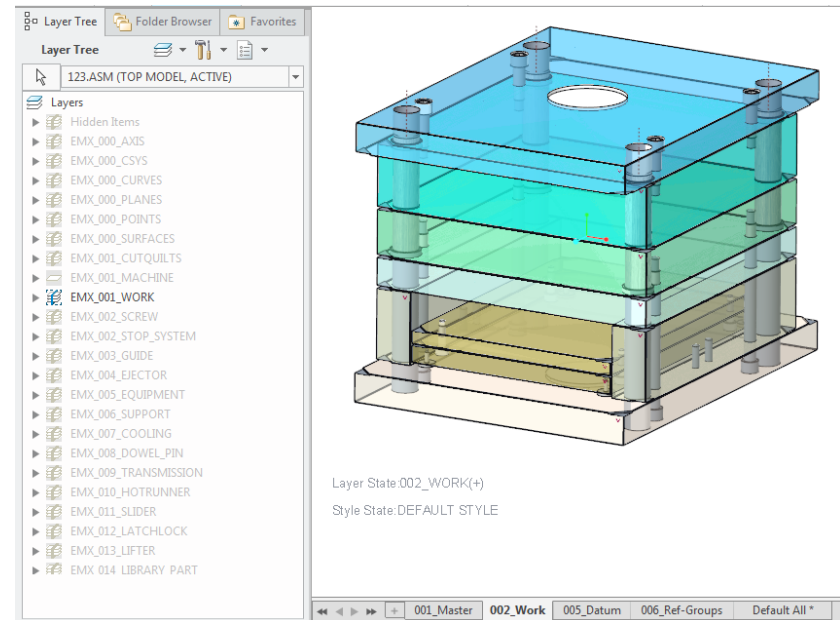

EMX 10 M010

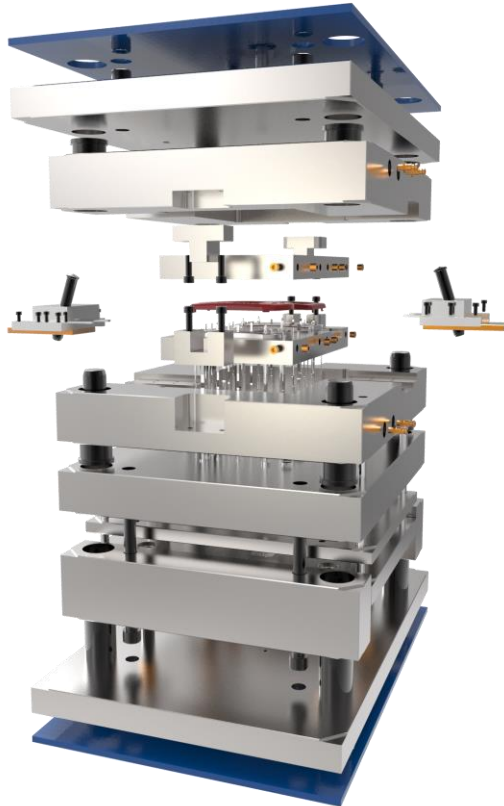

What's New?

- New Features
- Components

Components

New Components

- Hasco – Z14W: Guide bush
 - Hasco – Z09: Side interlock
 - Rabourdin – 1071, 1005, 1061, 651, 671 and 601: Guide Components
 - Knarr – 37711, 33111: Ejector Pins
 - Knarr – 38488, 38781, 38881: Ejector Sleeves
 - Progressive – SLX: X-Style Side Interlock
 - Meusburger – E2800: Stäubli cooling components
 - Strack – Z4290 Typ1: Compact Slider
- 
- A decorative graphic element consisting of a thick grey curved line and a thin orange curved line at the bottom right of the slide.

Components

Improved Components

- Meusburger – 3011, 3012, 3130: Slider Assembly
 - Hasco – single_locking: Slider Assembly
 - Input value is now REACH → Necessary pin length is suggested
 - EMX Assembly can contain subassemblies now
 - Hasco – Z170, Z173, Z174 Latchlocks
 - Strack – Z3, Z4, Z5 Latchlocks
 - Meusburger – E1820, E1840 Latchlocks
- 
- A decorative curved line in the bottom right corner, consisting of a grey outer curve and an orange inner curve.

EMX 10 F001

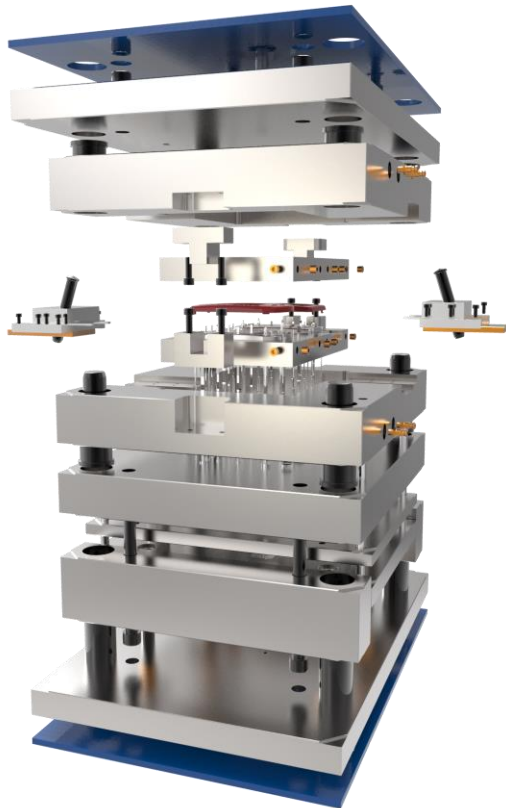

What's New?

- New Features
- Components

EMX 10 F001

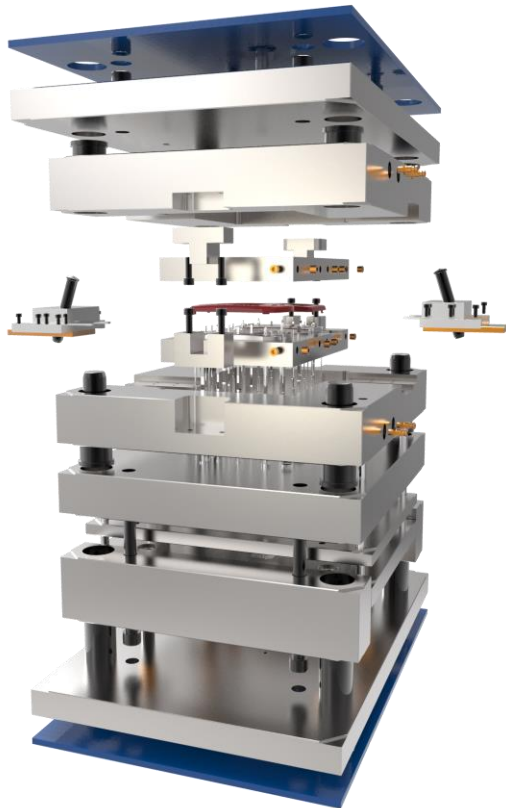

What's New?

- New Features
- Components

1. Enhanced Waterline Designer

Quick Selection of Components from Waterline List

- Predefine up to 4 default components in EMX Option

WATERLINE_DESIGNER_DEFAULT_COMPONENT mm|meusburger|E2080_8_10&&mm|meusburger|E2000_13_14&&mm|meusburger|E2130_11_8_2_4&&mm|meusburger|HOLE_8

- Use Right Mouse Button in table and assign quickly

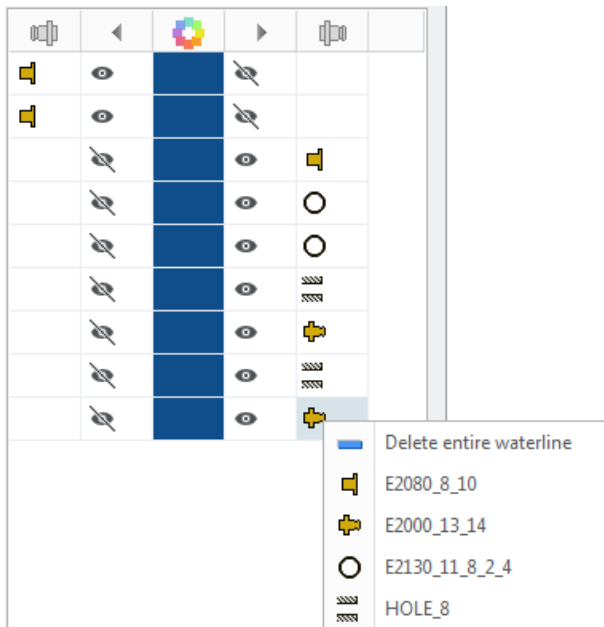

→ Design a complete cooling cooling circuit without opening the Component Dialog once!

1. Enhanced Waterline Designer

Define Waterlines on Existing Curves

(Only with B&W Direct License)

- Use existing curves in sketches as waterline reference
- New button → Select curves in current working model

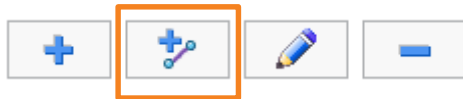

- Vertical waterlines will be attached to the existing curves and updated parametrically when sketch is modified

→ Benefit from parametric sketches and easy definition of cooling circuits

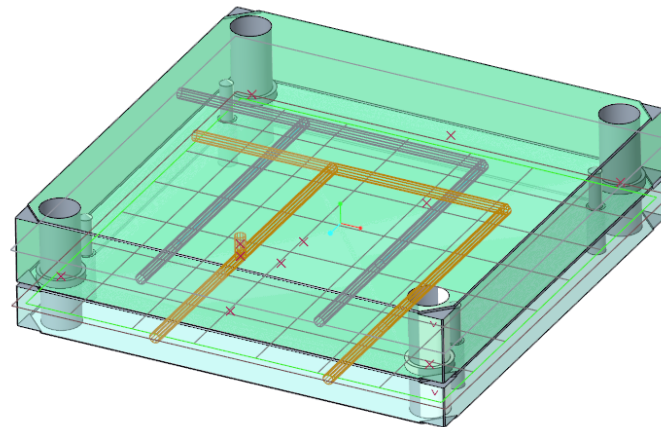

2. Toggle Wireframe Style

Fast Toggle of Wireframe Style from the Ribbon
(Only with B&W Direct License)

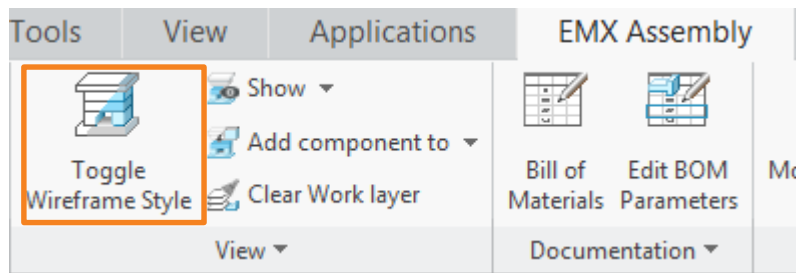

No need to open the View Manager anymore

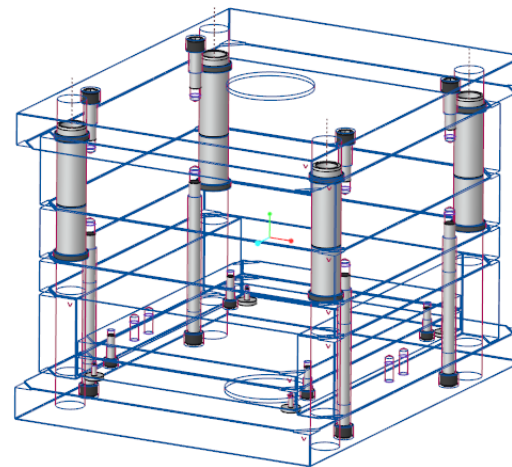
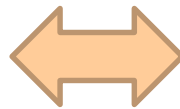
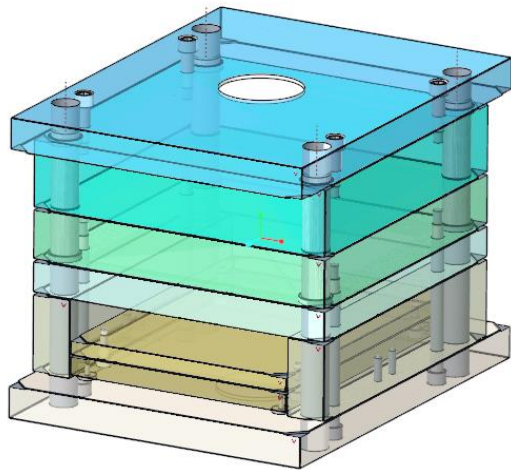

3. New Rule-Based Layer Concept

New Option `USE_RULEBASED_LAYER_CONCEPT`

- Layers are copied from template files in folder “configuration\templates\rules_layers.prt/asm”
 - Layer concept is completely customizable
 - Layers are not created by the software anymore
 - No more hardcoded layer names
 - Combined states and simplified representation are used to visualize datums and solids
 - WORK layer only shows recently created datums
- Avoids confusion with tons of datums in large assemblies

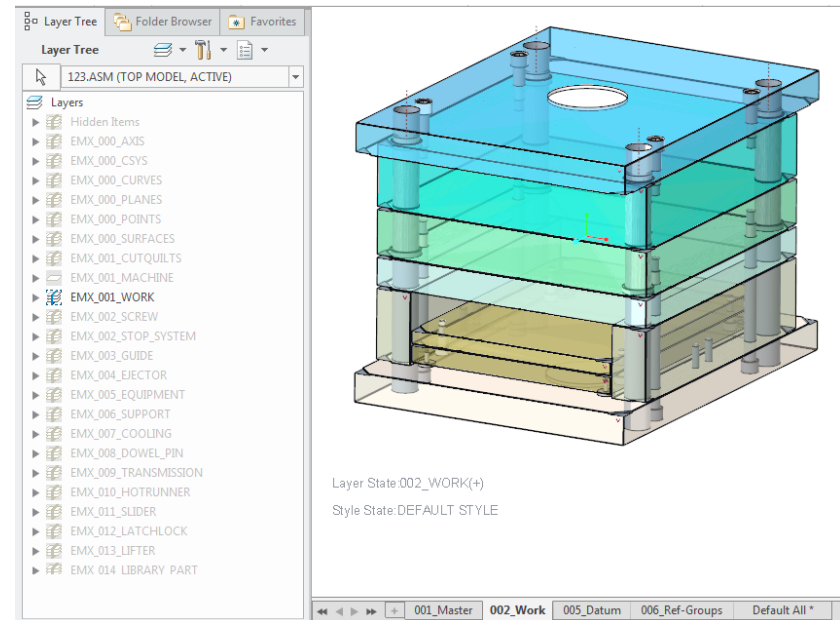

EMX 10 F001

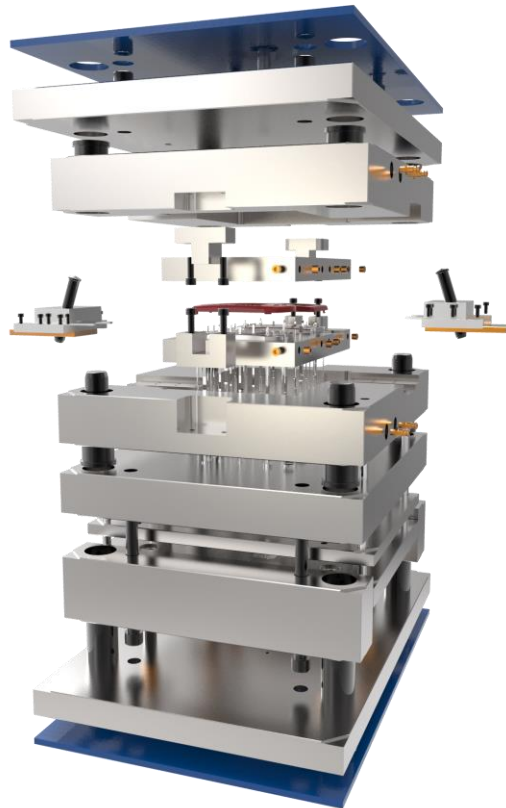

What's New?

- New Features
- **Components**
- 2. Deutsch
- Neue Funktionalität
- Komponenten

Components

New Components

- Hasco – Z14W: Guide bush
- Hasco – Z09: Side interlock
- Rabourdin – 1071, 1005, 1061, 651, 671 and 601: Guide Components
- Knarr – 37711, 33111: Ejector Pins
- Knarr – 38488, 38781, 38881: Ejector Sleeves
- Progressive – SLX: X-Style Side Interlock
- Meusbürger – E2800: Stäubli cooling components
- Strack – Z4290 Typ1: Compact Slider

Components

Improved Components

- Meusburger – 3011, 3012, 3130: Slider Assembly
- Hasco – single_locking: Slider Assembly
 - Input value is now REACH → Necessary pin length is suggested
 - EMX Assembly can contain subassemblies now
- Hasco – Z170, Z173, Z174 Latchlocks
- Strack – Z3, Z4, Z5 Latchlocks
- Meusburger – E1820, E1840 Latchlocks

EMX 10 F000

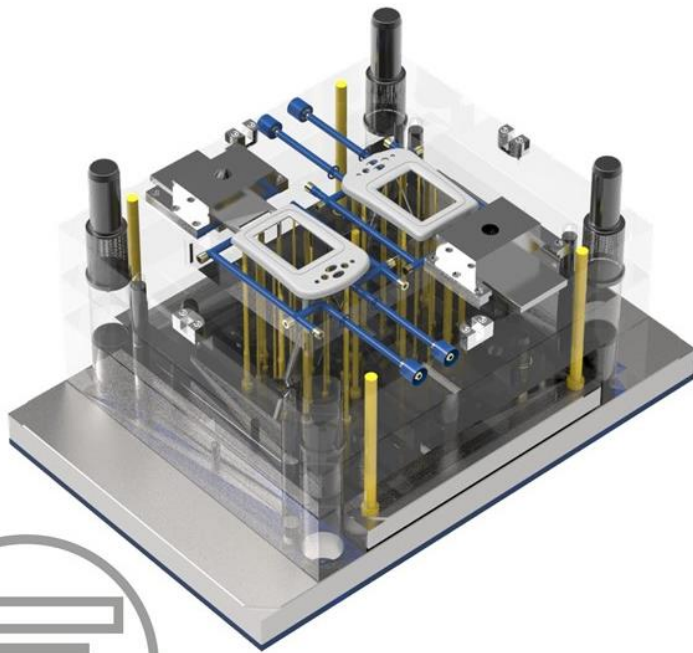

What's New?

- New Features
- Components



EMX 10 F000

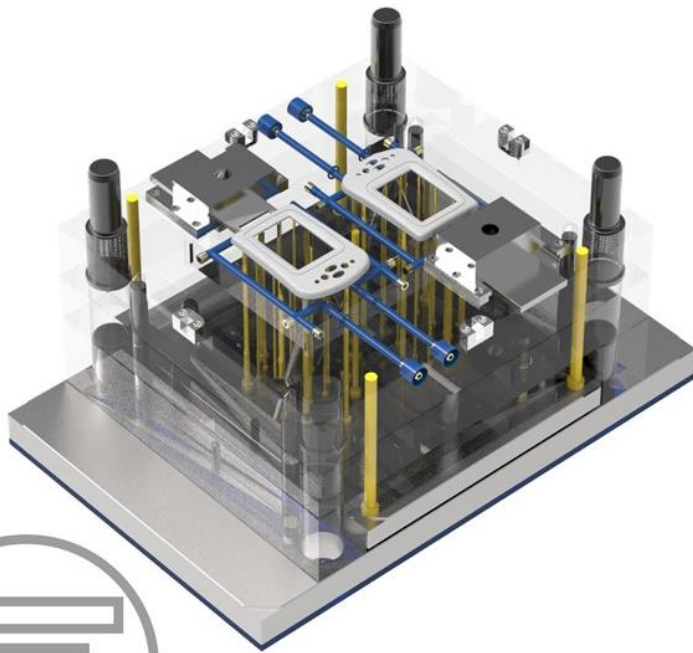

What's New?

- New Features
- Components



1. Improved EMX Ribbon

- New Design
- Improved Workflow

New Session

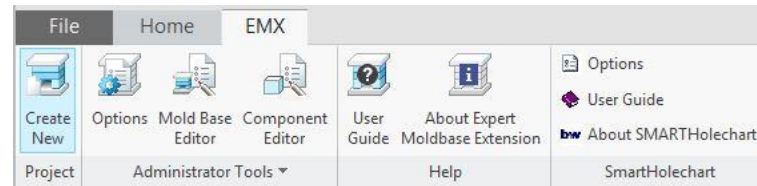

EMX Assembly

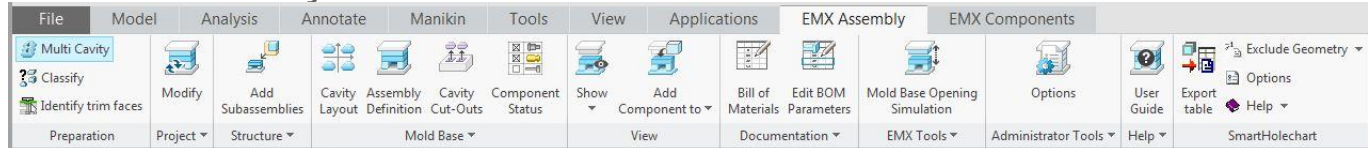

EMX Components

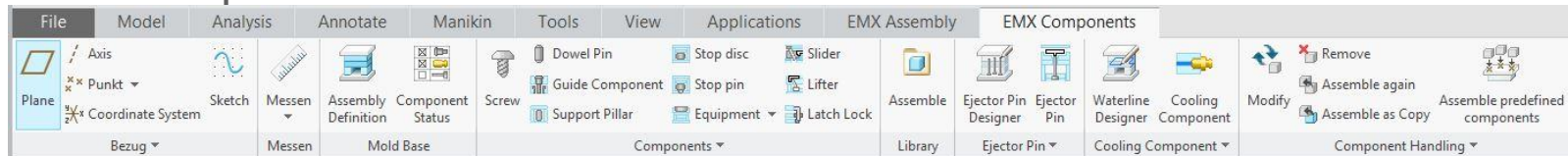

EMX Manufacturing



EMX Part Mode

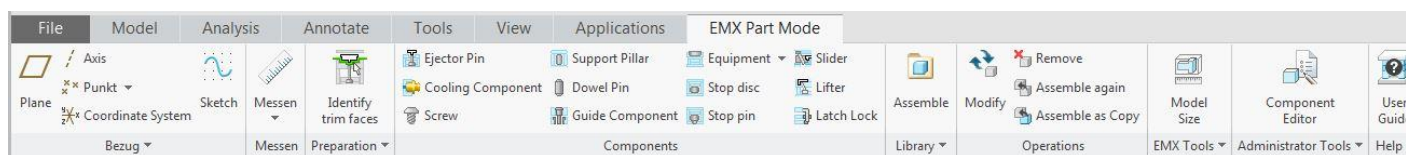

1. Improved Workflow

Preparation in Manufacturing Mode

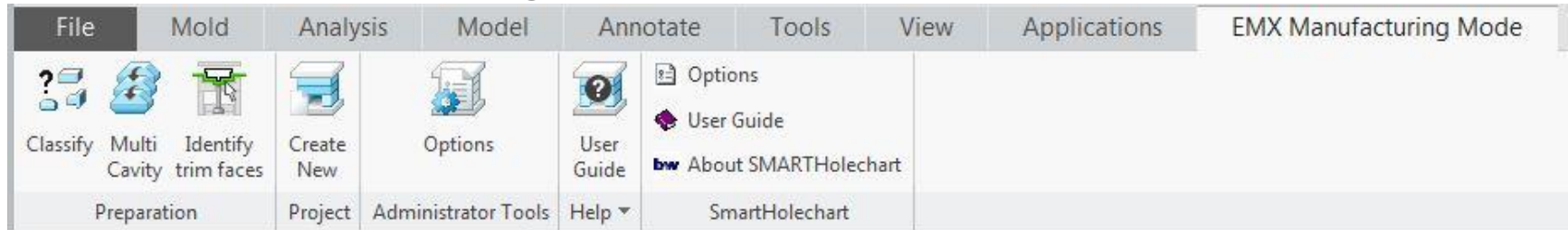

- 1.
- 2.
- 3.
- 4.

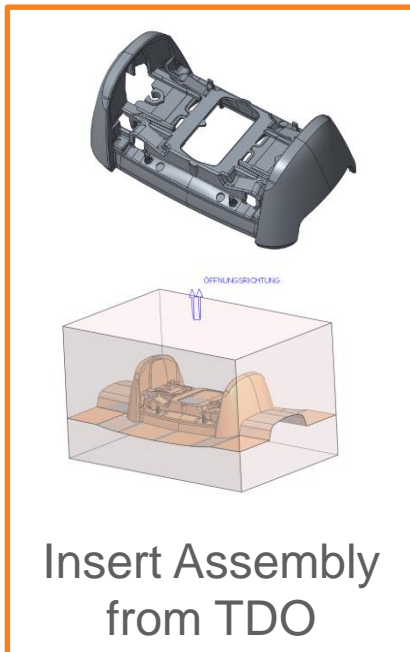

1. Classify Assembly
2. Multi Cavity Assemblies
3. Identify Trim Faces (**Enhanced**)
4. Create new Project

1. Improved Workflow

Mold Base in Assembly Mode

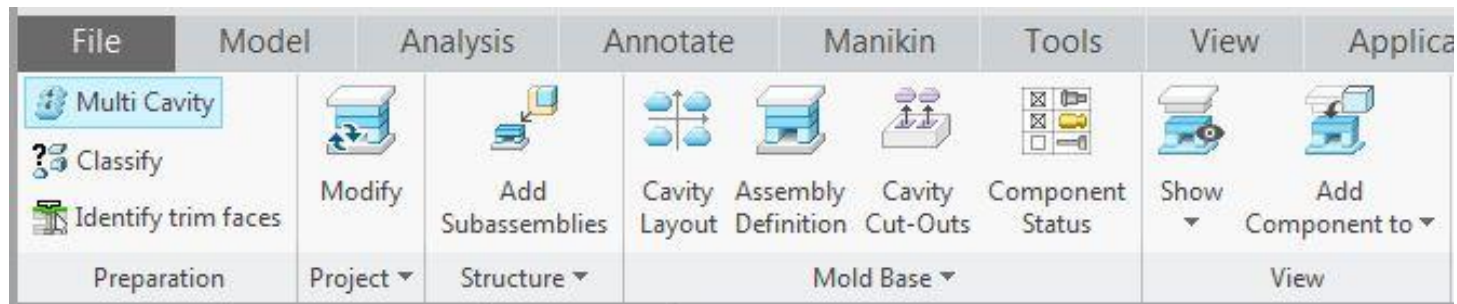

- 1.
- 2.
- 3.
- 4.
- 5.

1. Change Project
2. Set up Structure, Sub Assemblies (**Enhanced**)
3. Define Cavity Layout (**NEW**)
4. Define Mold Base(**Enhanced**)
5. Create Cavity Cuts (**NEW**)

1. Improved Workflow

EMX Components Part 1

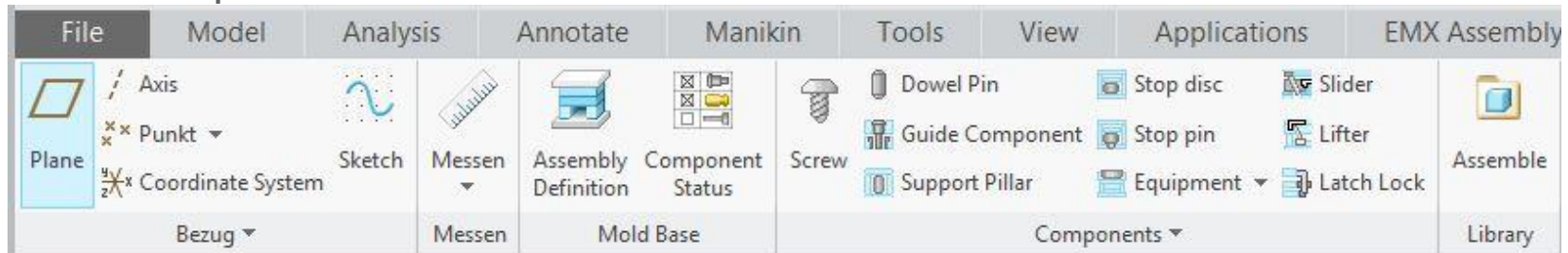

1.

2.

3.

4.

1. Datums und Measure (NEW)
2. Mold Base Definition und Component Status (NEW)
3. Assemble Components: All Types in 1 Group
4. Library Parts

1. Improved Workflow

EMX Components Part 2

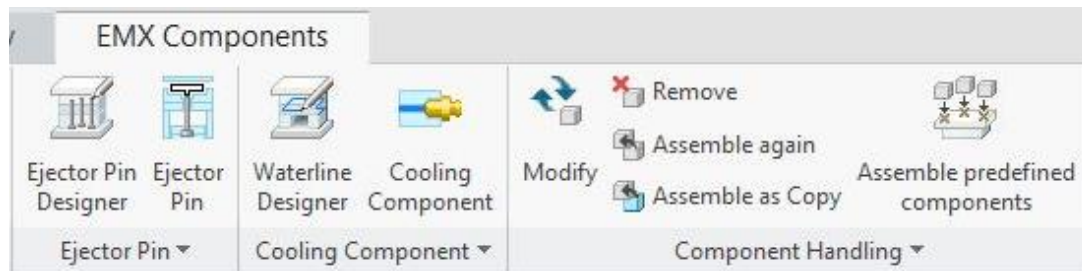

1.

2.

3.

1. Ejector Pins: Definition via Component Dialog or Ejector Pin Designer (**NEW**)
2. Cooling: Definition vis Component Dialog or Waterline Designer
3. Component Handling (**NEW**) , Predefined Components

2. Identify Trim Faces

In EMX 9:

Hidden in EMX Components → Ejector Pin

Now:

Ribbon Group EMX Assembly → Preparation

Function:

Mark Surface Quilt as Trim Surfaces for Ejector Pins and Lifters

Effect:

Don't trim via TDO Feature

Use Solidify instead



➡ More stable. Trimming is also possible when ejector cross-section exceeds the model volume

3. Enhanced Sub Assemblies

New in EMX 10:

Assign function to subassembly

Subassembly Data

Name: 1232343_SUB_01
Prefix: 1232343
Postfix: 456
subasm_function: Assembly

Templates

Copy Drawings
 Copy Reports

Parameter

Parameter Name	Value	Default Value
POS	?	?
QTY	1	1
PARTNAME	1232343_SUB_01	1232343_SUB_01
PARTID	1	1
BOM_NAME	Subassembly	Subassembly
SUPPLIER	-	-

1. Moving Half
2. Fix Half
3. Ejector Pins

3. Enhanced Subassemblies

Main assembly with 3 subasms and assigned functions

1. Moving Half
2. Fix Half
3. Ejector Pin

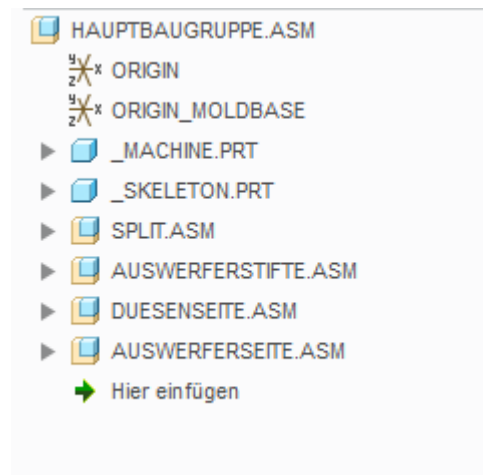

- Automatic pre-selection of MH/FH subasms when assembling from Mold Base Definition Dialog
- Automatic pre-selection for ejector pins

4. Cavity Layout Dialog

Simplified Placement of Insert Assemblies

- Define cavity pattern
- Load multiple insert assemblies
- Individual placement to cavity coordinate systems
- Assemble to main and sub assemblies
- Pattern insert assemblies
- 3D Preview

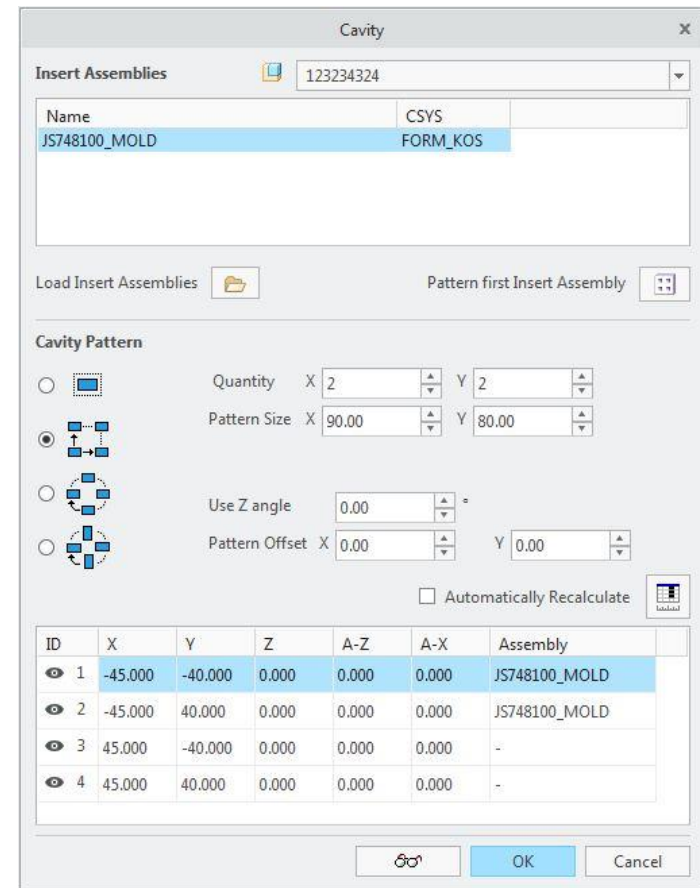

5. Cavity Cutout Dialog

Individual Dialog for Cavity Cutouts

- Functionality as known
- Cutout Types as known

New: 3D Preview

Cavity

Cavity Size

+X 45.000

-X 45.000

+Y 30.000

-Y 30.000

+Z 20.000

-Z 35.000

Cavity Cutout

Cut Depth MH 35.000

Cut Length MH 90.000

Cut Width MH 60.000

Cut Depth FH 20.000

Cut Length FH 90.000

Cut Width FH 60.000

With Mouse Ear



Cut Radius 0.000

OK Cancel

6. New Component Handling

	EMX 9	EMX 10
Ribbon	<p>Delete Modify As Copy Reassemble</p> <p>For each Component Type → Redundant</p>	<p>Delete Modify As Copy Reassemble</p> <p>1x for all Component Type → Looks much better</p>
RMB	<p>Only Delete Modify</p>	<p>All Functions Delete Modify As Copy Reassemble</p>

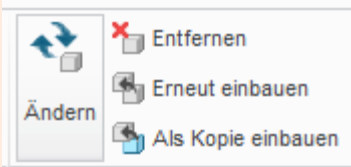
6. New Component Handling

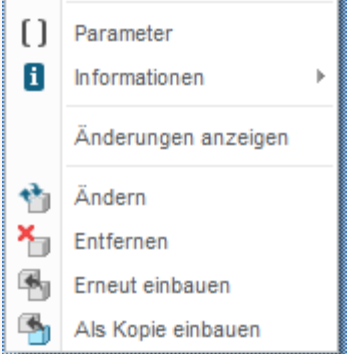
	EMX 9	EMX 10
Ribbon	 <p>The EMX 9 ribbon features a grid of buttons, each labeled 'Definieren' (Define) with a small red 'x' icon. The buttons are arranged in four rows and four columns. The second row, second column button is labeled 'Kühlkanal-Designer'.</p>	 <p>The EMX 10 ribbon shows a context menu with four options: 'Ändern' (Change) with a circular arrow icon, 'Entfernen' (Remove) with a red 'x' icon, 'Erneut einbauen' (Reinstall) with a refresh icon, and 'Als Kopie einbauen' (Install as copy) with a copy icon.</p>
Rechte Maus	 <p>The EMX 9 right-click context menu includes: 'Parameter' with a bracket icon, 'Informationen' with an information icon and a right-pointing arrow, 'Änderungen anzeigen' (Show changes), 'Komponente ändern' (Change component) with a refresh icon, and 'Komponente entfernen' (Remove component) with a red 'x' icon.</p>	 <p>The EMX 10 right-click context menu includes: 'Parameter' with a bracket icon, 'Informationen' with an information icon and a right-pointing arrow, 'Änderungen anzeigen' (Show changes), 'Ändern' (Change) with a circular arrow icon, 'Entfernen' (Remove) with a red 'x' icon, 'Erneut einbauen' (Reinstall) with a refresh icon, and 'Als Kopie einbauen' (Install as copy) with a copy icon.</p>

7. Ejector Pin Designer

➔ Dynamic Definition of Ejector Pins

New Main Feature in EMX 10

- 1. Place Ejectors with 2D Preview
- 2. Place to Fix Half and Moving Half
- 1. Supports 2nd ejector package
- 2. Assemble to all sub asms

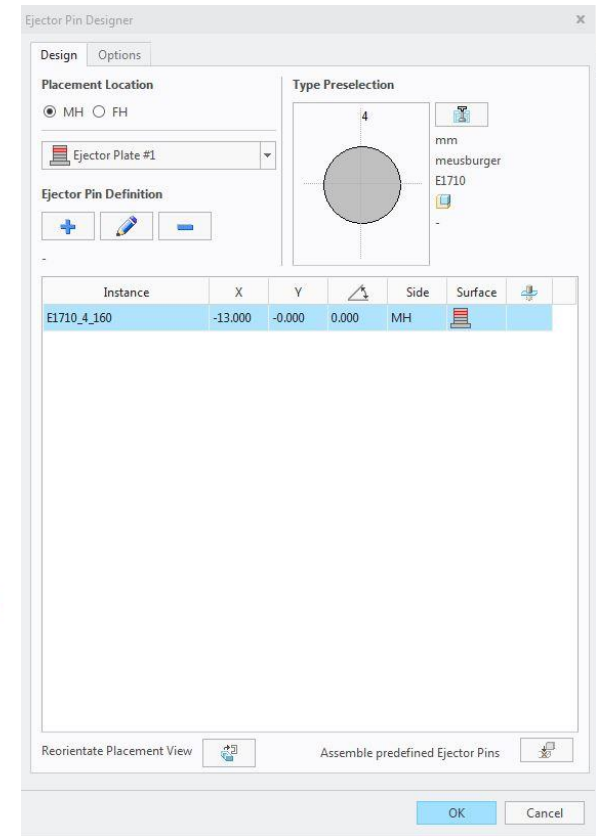
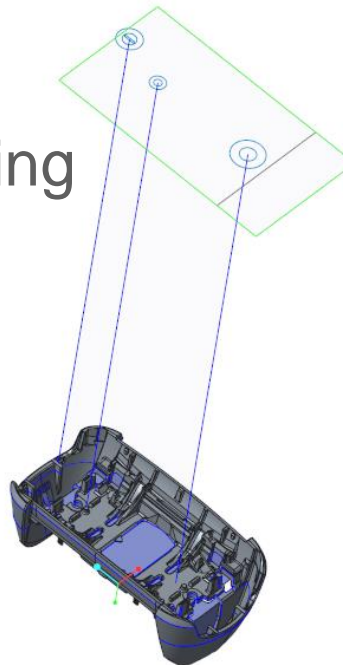

8. New Data Structure

Migration from `comp_data.txt` & `udf_data.txt` to `*.dat` Files

In **EMX 10** each component an individual `*.dat` file will be shipped. This file contains all required information to handle:

- a) The component data (assembly constraints, nominal values, instances, etc.)
- b) The entire cut-information (UDFs , UDF options, etc.)

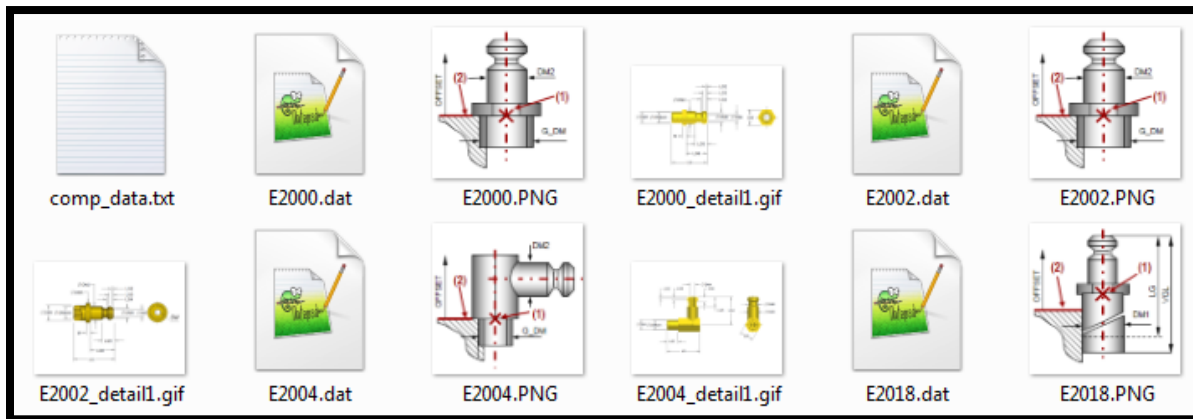

9. Convert to EMX 10 Data Structure

Conversion of old comp_data.txt files can be done **step by step**

- Open EMX → Administrator Tools
→ **Component Editor**



- Select Button **Split comp_data.txt file**

- Select a EMX 9 formatted **comp_data.txt** file in File Open Dialog

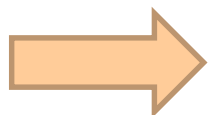

Splitting process is triggered

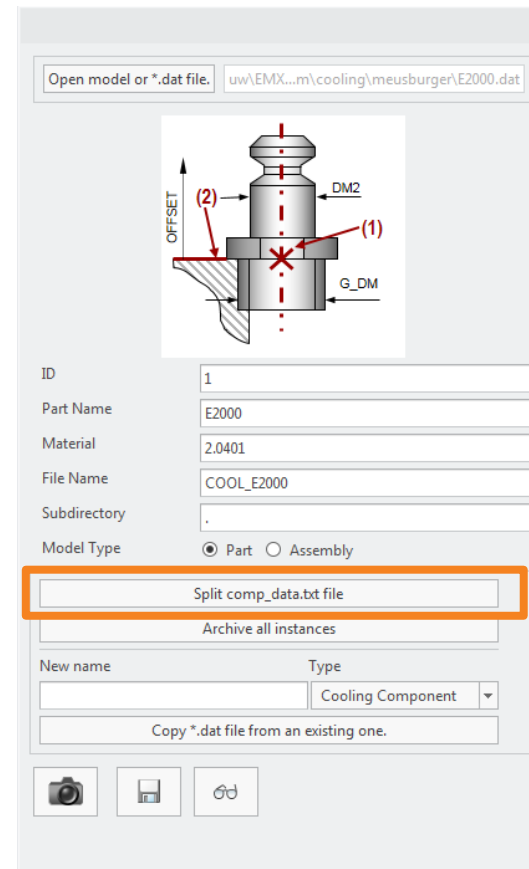

10. Facelift for new Component Editor

Conversion of old comp_data.txt files can be done **step by step**

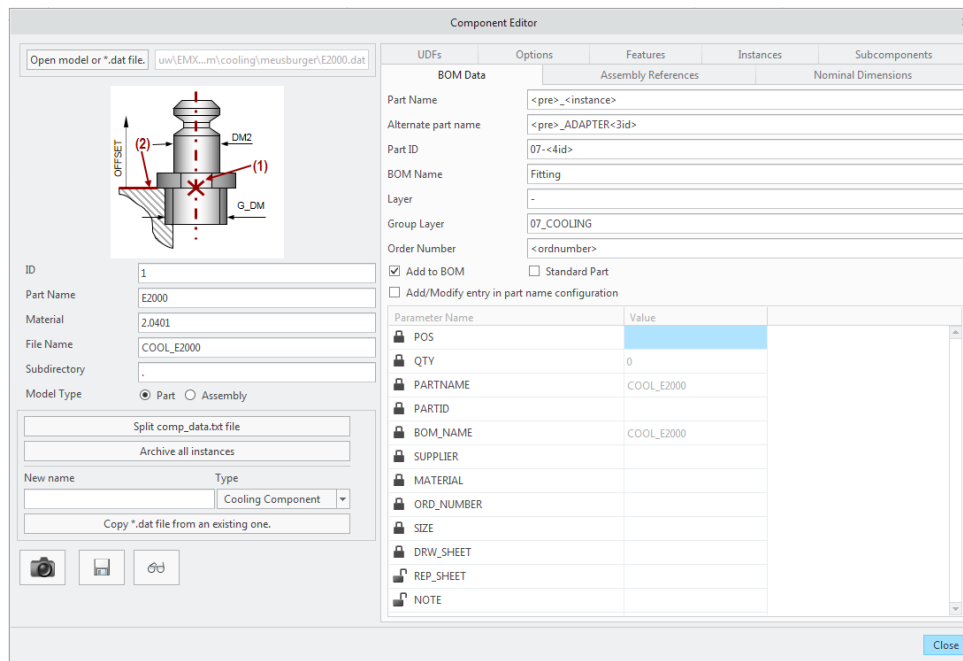

New Features:

- Copy Component from existing template
- Work on UDF cutout information
- Archive all instances from a component

10. New EMX Help Center

EMX 10 comes with the **new EMX Help Center**

- Handy Search functionality
- What's new Videos

Creo Expert Moldbase Extension > What's New in Creo Expert Moldbase Extension (EMX) > Workflow Is Easier

Workflow Is Easier

An updated EMX Ribbon with new layout and icons improves the ease of interaction.

Release: Creo Expert Moldbase Extension 10.0

Benefits and Description

You can watch a video that demonstrates this capability.

Improved EMX Workflow

The new ribbon layout and the new icon design improves the user experience and clarifies the mold base design process. The EMX commands are positioned in a way that designing the mold base can be done step by step beginning with the cavity assembly up to a finished project. Preparation of the cavity assembly is available in Creo Parametric manufacturing mode and Creo Parametric assembly mode.

[Back to top](#)

11. Smart Holechart 10.0

Integrated new Version in EMX 10

- Collision Tables
- easy UDF Recognition
- Replace existing Tables
- Adapt Number of Table Columns during Refresh
- Direction-depended Bore Definition
- Automatic creation of Point/Axis in Bore Center
- Use Tolerances (e.g. H7) as criteria for bore types
- Man more Options

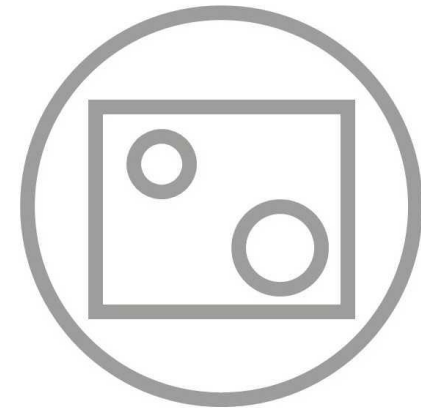

11. Smart Holechart 10.0

SHC – Default EMX Configuration

- Smart Holechart 10 comes with a default EMX - adapted configuration
- UDFs and Holes created by EMX can be recognized easily



12. Placement of BOM Balloons

Improvements

- Functions to RMB
- Multiple Selection and Placement in a Loop
- Place Balloon multiple times for summarized components
- New Design

The image shows a BOM table titled 'Stückliste' and a technical drawing of a mechanical assembly with balloons numbered 1 through 6.

E...	V...	MODELL	POS	QTY	(V) PARTNAME
		BALL_CAV_PLATE_FH001	1	1	BALL_CAV_PLATE_FH001
		B...		1	BALL_CAV_PLATE_MH001
		B...		1	BALL_RISERS_R_MH001
		B...		1	BALL_RISERS_L_MH001
		B...		1	BALL_CLP_PLATE_MH001
		B...		1	BALL_CLP_PLATE_FH001
		B...		1	BALL_EJRET_PLATE_MH001
		BALL_EJBASE_PLATE_MH001	8	1	BALL_EJBASE_PLATE_MH001
		BALL_E1000_22_56_35	9	4	BALL_E1000_22_56_35
		BALL_E1160_30_80	10	4	BALL_E1160_30_80
		BALL_E1100_22_56	11	4	BALL_E1100_22_56
		BALLON_PLACEMENT	12	1	BALLON_PLACEMENT
		BALL_MACHINE	13	1	BALL_MACHINE
		BALL_SKELETON	14	1	BALL_SKELETON

The technical drawing below the table shows a cross-section of a mechanical assembly. Six balloons are placed on the drawing, numbered 1 through 6, pointing to various components. Balloons 1, 2, 3, and 5 are placed on the top part of the assembly, while balloons 4 and 6 are placed on the bottom part.

12. Placement of BOM Balloons

Improvements

- Place same balloon of component multiple times in different views

The image shows three technical drawings of a machine component. Each drawing has a blue circle with the number '1' pointing to a specific part, illustrating the placement of a BOM balloon across multiple views.

E...	V...	MODELL	POS	SIZE
<input checked="" type="checkbox"/>	<input checked="" type="checkbox"/>	BALLON_CLP_PLATE_MH001	1	156.000x156.000x27.000
<input checked="" type="checkbox"/>	<input checked="" type="checkbox"/>	BALLON_ESBASE_PLATE_MH001	2	156.000x92.000x13.000
<input checked="" type="checkbox"/>	<input checked="" type="checkbox"/>	BALLON_EJRET_PLATE_MH001	3	156.000x92.000x9.000
<input checked="" type="checkbox"/>	<input checked="" type="checkbox"/>	BALLON_RISERS_R_MH001	4	156.000x40.000x34.866
<input checked="" type="checkbox"/>	<input checked="" type="checkbox"/>	BALLON_RISERS_L_MH001	5	156.000x40.000x33.509
<input checked="" type="checkbox"/>	<input checked="" type="checkbox"/>	BALLON_INT_PLATE_MH001	6	156.000x156.000x27.000
<input checked="" type="checkbox"/>	<input checked="" type="checkbox"/>	BALLON_CAV_PLATE_MH001	7	156.000x156.000x46.000
<input checked="" type="checkbox"/>	<input checked="" type="checkbox"/>	BALLON_CAV_PLATE_FH001	8	156.000x156.000x40.000
<input checked="" type="checkbox"/>	<input checked="" type="checkbox"/>	BALLON_CLP_PLATE_FH001	9	156.000x156.000x34.925
Hidden Parts List				
<input checked="" type="checkbox"/>	<input checked="" type="checkbox"/>	BALLON	10	*
<input checked="" type="checkbox"/>	<input checked="" type="checkbox"/>	BALLON_MACHINE	11	*
<input checked="" type="checkbox"/>	<input checked="" type="checkbox"/>	BALLON_SKELETON	12	*

13. Enable Cell Colors in Comp Dialog

Improvements

```
!listing of nominal dimensions
!NAME      DISPLAY_NAME  DIM_NAME  TYPE
EMX NOM_VALUES
E1200      diameter     DM1       PULLDOWN
E1200      length       LG1       PULLDOWN    >REF1
E1200      offset       OFFSET    EDIT
E1200      distance     REF1     DISABLED
E1200      color        COLOR    COLOR
EMX NOM_VALUES END
```

INSTANCE	ORD_NUMBER	USER_NUMBER	PRICE	COLOR
E1200_2_6	E1200/2x6	-	0	100,100,100
E1200_2_8	E1200/2x8	-	0	GREEN
E1200_2_10	E1200/2x10	-	0	RED
E1200_2_12	E1200/2x12	-	0	YELLOW
E1200_2_16	E1200/2x16	-	0	BLUE
E1200_2_20	E1200/2x20	-	0	ORANGE
E1200_2_5_12	E1200/2,5x12	-	0	RED
E1200_3_6	E1200/3x6	-	0	RED
E1200_3_8	E1200/3x8	-	0	RED
E1200_3_10	E1200/3x10	-	0	RED
E1200_3_12	E1200/3x12	-	0	RED
E1200_3_14	E1200/3x14	-	0	RED
E1200_3_16	E1200/3x16	-	0	RED
E1200_3_20	E1200/3x20	-	0	RED
E1200_3_25	E1200/3x25	-	0	RED
E1200_3_30	E1200/3x30	-	0	RED
E1200_3_35	E1200/3x35	-	0	RED
E1200_3_40	E1200/3x40	-	0	RED
E1200_4_6	E1200/4x6	-	0	RED
E1200_4_8	E1200/4x8	-	0	RED
E1200_4_10	E1200/4x10	-	0	RED
E1200_4_12	E1200/4x12	-	0	RED

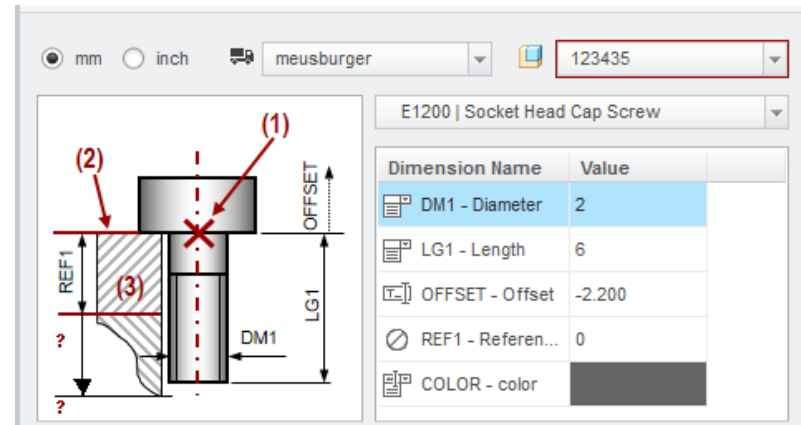
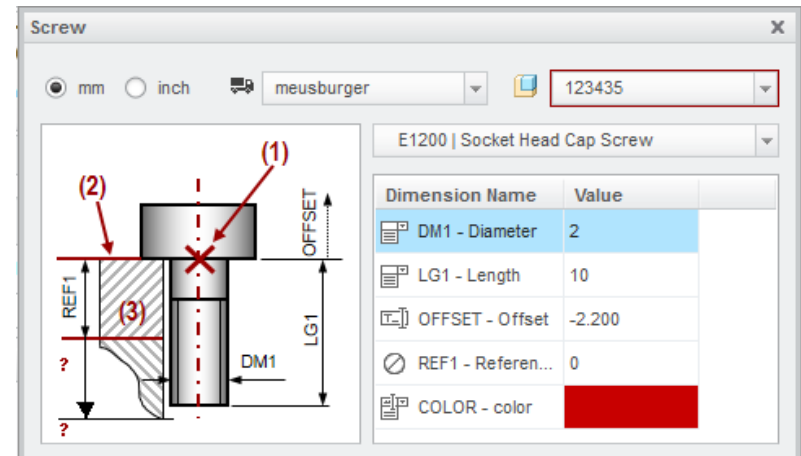

14. Add Relations to Post Regen Area

Improvements

- Add Relations to Post Regeneration Area with specified files
1. emx_comp_post_regen.rel
 2. plate_post_regen.rel
 3. etc.

Name	Änderungsdatum	Typ	Grö
emx_bom.xls	06.04.2016 09:44	Microsoft Excel 97...	
emx_bom_adv.xls	25.08.2016 13:28	Microsoft Excel 97...	
emx_comp.rel	09.09.2016 08:58	REL-Datei	
inactive_emx_comp.rel	06.04.2016 09:44	REL-Datei	
inactive_ref_feat_udf.gph	06.04.2016 09:44	Creo User defined ...	
insert_asm.asm	25.08.2016 13:28	Creo Assembly File	
insert_asm_inch.asm	06.04.2016 09:44	Creo Assembly File	
insert_comp.prt	06.04.2016 09:44	Creo Part File	
insert_comp_inch.prt	06.04.2016 09:44	Creo Part File	
view_layer_template_german.prt	25.08.2016 13:28	Creo Part File	
view_layer_template_usascii.prt	25.08.2016 13:28	Creo Part File	
emx_comp_post_regen.rel	09.09.2016 10:40	REL-Datei	

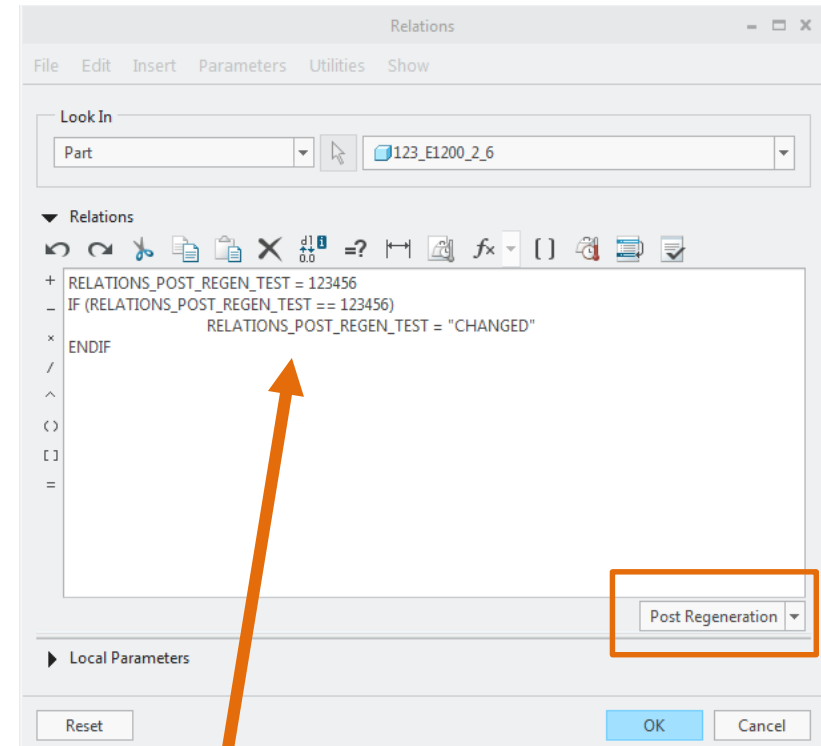

```

1 RELATIONS_POST_REGEN_TEST = 123456
2 IF (RELATIONS_POST_REGEN_TEST == 123456)
3     RELATIONS_POST_REGEN_TEST = "CHANGED"
4 ENDIF
    
```

15. Windchill Autonumber Renaming

Improvements

- New Option WINDCHILL_AUTONUMBER
- When working with Windchill and option is set to YES EMX uses next valid name in Windchill for renaming
- Windchill Common Name is set by standard naming mechanism defined in partnames.cfg
- Use keyword WINDCHILL_AUTONUMBER as rule in partnames.cfg to apply auto renaming for individual components

16. Angular Cutouts for Guides and Screws

Enhancement

Screws and Guides can now be placed on Axis/Points and Planes which are not orthogonal to each other.

→ Cutouts will be created with given angle.

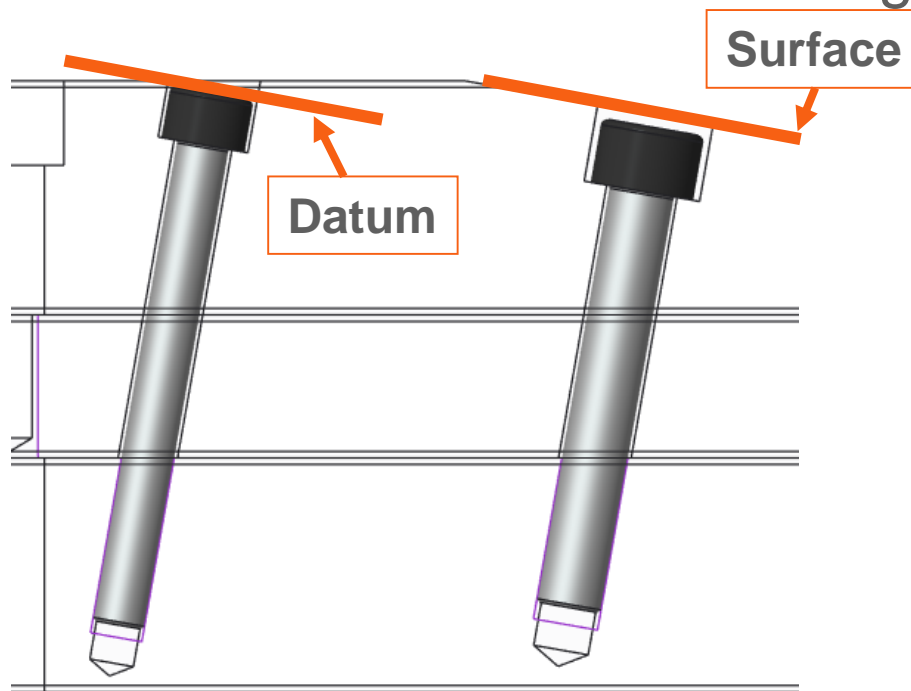

Note

Works with EMX standard configuration.

If you use a custom configuration following UDFs need to be added to custom config:

```
"<emx_install>\components\mm\screw\udf
1. screw_straight_hole_coax.gph
2. screw_thread_bore_coax.gph
"<emx_install>\components\mm\guides\udf
1. guide_straight_hole_coax.gph
2. guide_blind_hole_coax.gph
```

17. Ignore Subcomps of ASMs in BOM

Enhancement

Purchased assemblies can be marked in BOM
 → All subassemblies and sub components will be ignored in BOM

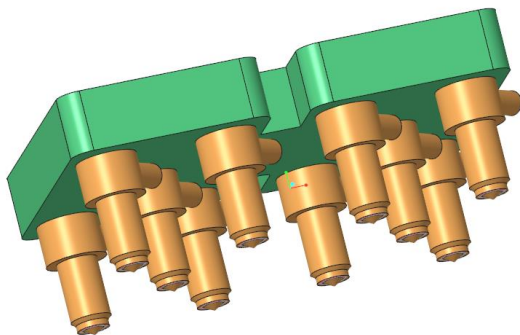

		HOT_12MATRIX001	20
		HOT_12MATRIX001	21
		123_BI-METALLIC_C-SPRUE002	22
		123_SEAL2002	23
		123_HOTSPRUE2	24
		123_SEAL1002	25
Hidden Parts List			
		HOTRUNNER	26
		HOT_MACHINE	27
		HOT_SKELETON	28

Default: All parts and subassemblies are listed in BOM.

		HOT_E1010_22_56_75	17
		HOT_E1100_24_76	18
		HOT_E1100_22_76	19
		HOT_12MATRIX001	20
Hidden Parts List			
		HOTRUNNER	21
		HOT_MACHINE	22
		HOT_SKELETON	23

Mark assembly as purchased part with RMB functionality.



Status displayed with Icon.

18. Cut and Paste with Ctrl+X / Ctrl+V in BOM

Enhancement

Cut and Paste can now be done with keyboard shortcuts Ctrl+X and Ctrl+V.

→ Quick repositioning of BOM entries.

		HOT_CAV_PLATE_FH001	9	1	HOT_CAV
		HOT_CLP_PLATE_FH001	10	1	HOT_CLP
		HOT_STOP_DISC			STO
		HOT_STOP_ASM			STO
		HOT_E1200_12_1			E120
		HOT_E1200_12_4			E120
		HOT_E1200_8_25			E120
		HOT E1010 24 56 75	16	3	HOT E101

- Edit BOM Parameters
- Cut
- Paste
- Show/Hide Items
- Mark/Unmark a purchased Part/Assembly

19. Search Feature in BOM Dialog

Enhancement

Search for Keywords in BOM to find entries.
 Found entries are highlighted in list.

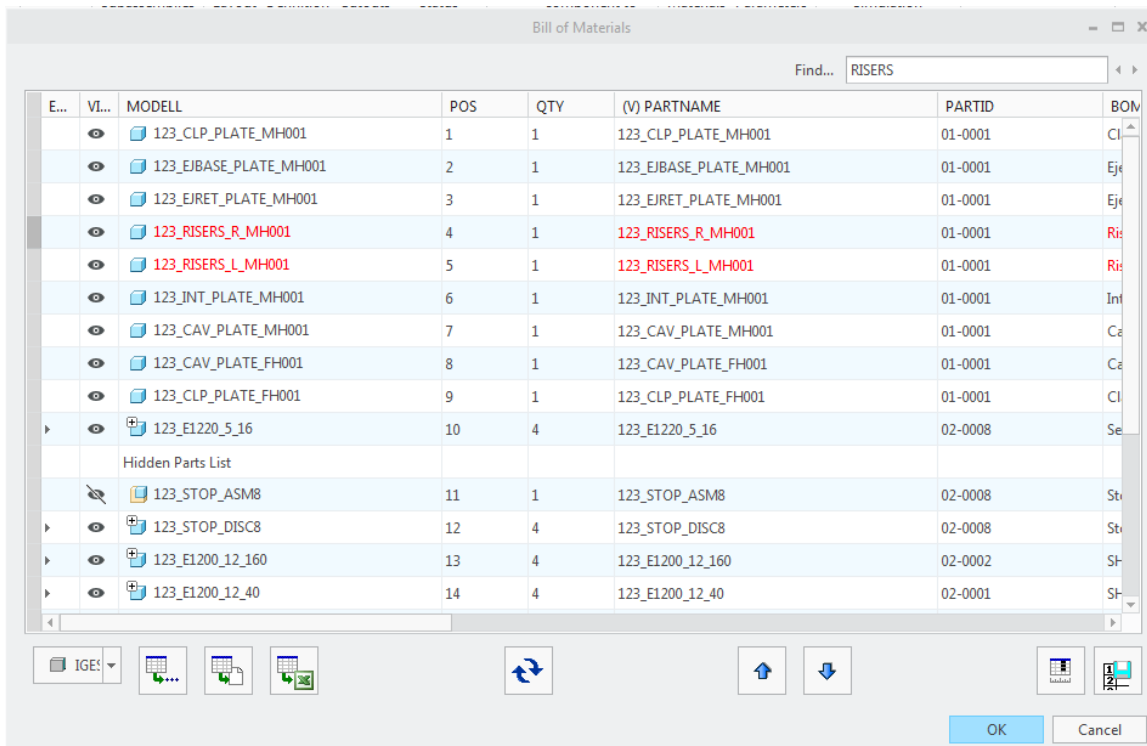

EMX 10 F000

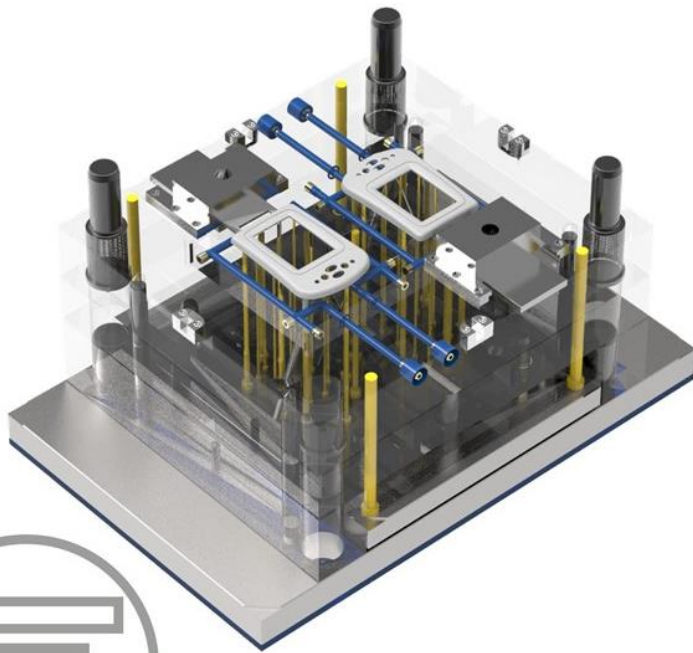

What's New?

- New Features
- Components



Components

New Components

- Misumi – Cooling NPW and M-KOC
 - Misumi – Top Lock TPN
 - Misumi – Flat Ejector Pin ESHJ, ERZF and ERVB
 - Meusburger – Guide E10025
 - Meusburger – Ejector Pin E10125 (DLC Coated)
 - Meusburger – Spring E1546
 - Hasco – Guide Z040
 - Hasco – Locating Ring K107, K501, K506, K1000
 - Knarr – Ejector Pin 37999
 - Strack - Z17, Z18 Locating Rings
 - Strack - Z45 side interlock components
- 
- A decorative graphic element consisting of a thick grey curved line with a thin orange line underneath it, located in the bottom right corner of the slide.

Components

New Components

- Meusburger – Guide E1032: Inclined Pin
 - Meusburger – Locating Ring E1362
 - Meusburger – Screw E1514: Threaded Bolt
 - Meusburger – Cooling E2800: Stäubli Connector
 - Knarr – Ejector Pin 36555
 - Knarr – Ejector Pin 36599
 - Knarr – Ejector Pin 37414
 - Knarr – Ejector Pin 37555
 - Knarr – Ejector Pin 37888
 - WEMA – Cooling S3102: Sealing Plug
 - WEMA – Cooling S3105: Diverting Plug
 - WEMA – Cooling S3111: Core Cooling Element
 - WEMA – Cooling S3113: Core Cooling Element
 - WEMA – Cooling S3115: Baffle Cooling Element
 - WEMA – Cooling S3117: Spiral Baffle Cooling Element
- 
- A decorative graphic element consisting of a thick grey curved line with a thin orange line underneath it, starting from the bottom right and curving towards the center.

Components

Updated Components:

- Hasco – Locating Ring K100
 - Hasco - Side Interlock Z18/19
 - Hasco – Cooling O-Ring Z98
 - LKM – Side interlocks
 - Meusburger - Insulation Plates E1402 E1403 E1407 E1408
 - Meusburger – Top Interlock E1310
 - PCS – Ejector Pins: All Types Verify and Updated
 - PCS – Support Pillars
 - PCS – Locating Rings
 - Hasco – Locating Ring K100
 - Hasco - Side Interlock Z18/19
 - Hasco – Cooling O-Ring Z98
 - LKM – Side interlocks
 - Meusburger - Insulation Plates E1402 E1403 E1407 E1408
- 
- A decorative curved line in the bottom right corner, consisting of a grey outer curve and an orange inner curve.

Components

Updated Components:

- Misumi – Ejector Pins Type Verified
 - Meusburger - Ejectors E1712 add Rotation Fixtures option
 - Meusburger – Top Interlock E1310
 - PCS – Ejector Pins: All Types Verify and Updated
 - PCS – Support Pillars
 - PCS – Locating Rings
- 
- Decorative curved lines in the bottom right corner, consisting of a thick grey arc and a thin orange arc.

Components

Updated Plates:

- Futaba - Catalog – All sizes checked and updated
- Meusburger - Plates updated
- Meusburger - E2071 Add option Counter/Second Bore