



# SMARTElectrode 13.1.0.0

*What's New*



# Fixed error

## Description

- Allow renaming of manufacturing assembly and workpiece in Manufacturing UI and Rename UI.

- <https://redmine.buw-soft.de/issues/13988>

## Cause

- A renamed electrode may not meet the naming format anymore
- Allow edit of default MFG and workpiece name in Manufacturing UI.
- Allow adjusting of names of existing MFG and workpiece during rename.

## Solution

- Double click Mfg or Workpiece name in Manufacturing UI to edit names for objects to create (📄). Existing assemblies and parts (✅) can't be renamed Manufacturing UI.
- Rename UI shows input panels for MFG and workpiece if available.

ID	Electrode	Size	Status	Mfg Name	Workpiece Name	Template
1	SE_CREO8_EDM_01	15.0x15.0x28.0	✅	SE_CREO8_MFG_01	SE_CREO8_WP_01	mfg_default.asm
2	SE_CREO8_EDM_02	15.0x15.0x28.0	📄	SE_MFG_02	SE_CREO8_WP_02	

Rename

Electrode SE\_CREO8\_EDM\_01

New Name SE\_CREO8\_EDM\_01

Manufacturing SE\_CREO8\_MFG\_01

Workpiece SE\_CREO8\_WP\_01

OK Cancel

# Improvement

What

- Prefer template without rotation ( $C=0^\circ$ ) if several templates with same blank dimensions are available.

Why

- <https://redmine.buw-soft.de/issues/13672>
- Order of templates in .dat decided which template - with or without rotation - was assigned. This is improved by defined behavior.

How

**Current Behavior**

A	0.00
B	0.00
C	90.00

Z 5.0000

Blank  
Type RECTANGULAR\_BASE  
Size 10X50

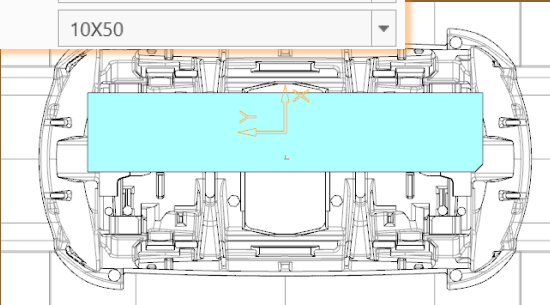

**New Behavior**

A	0.00
B	0.00
C	0.00

Z 5.0000

Blank  
Type RECTANGULAR\_BASE  
Size 50X10

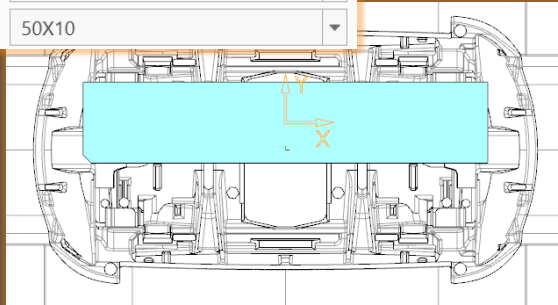

# Fixed error

## Description

- Ignore rotation of EDM\_ORIGIN for default start and secure position
- <https://redmine.buw-soft.de/issues/13878>

## Cause

- In some cases a rotated EDM\_ORIGIN is useful
  - Easier definition of start position
  - EDM\_ORIGIN is rotated for later NC setup
- In both cases either the calculated angles or the display are wrong

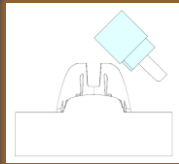

SX	SY	SZ	SA
0.000	18.887	1.571	-45.000

## Solution

- Applied rotation to EDM\_ORIGIN is ignored for calculation of angles.
- SE\_EDM\_BASE is used for electrodes created in current releases.
- EDM\_ORIGIN is used for electrodes created in versions prior 8.0.

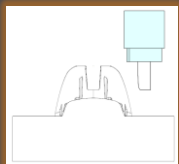

SX	SY	SZ	SA
0.000	18.887	1.571	0.000

# Enhancement

## What

- BREAKING CHANGE
- Consider contour height on calculation of default start- and secure-position.  
<https://redmine.buw-soft.de/issues/13762>

## Why

- Calculation of default start and secure position using EDM\_ORIGIN led to disadvantageous or wrong values.
- Reduce effort to set start and secure positions.

## How

- **NOTE:** Adjustment of operation default planes may be necessary to respond appropriately to the new behavior.
- New behavior is available for all assemblies from current versions.

Current Behavior

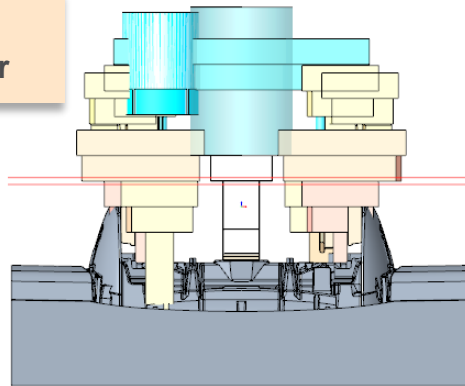

New Behavior

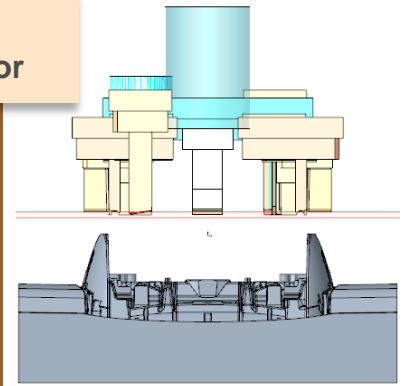

# Enhancement

## What

- Introduce new option #Electrode #LATERAL\_KEEPOUT\_DISTANCE  
<https://redmine.buw-soft.de/issues/13766>

## Why

- Defines the minimum distance in XY direction from the base that must not be disturbed by workpiece geometry.

## How

- Default value '0'
- When adding a new base, position will be adjusted to...
  - ...meet normal distance D1 and
  - ...to fulfill lateral offset defined in LATERAL\_KEEPOUT\_DISTANCE

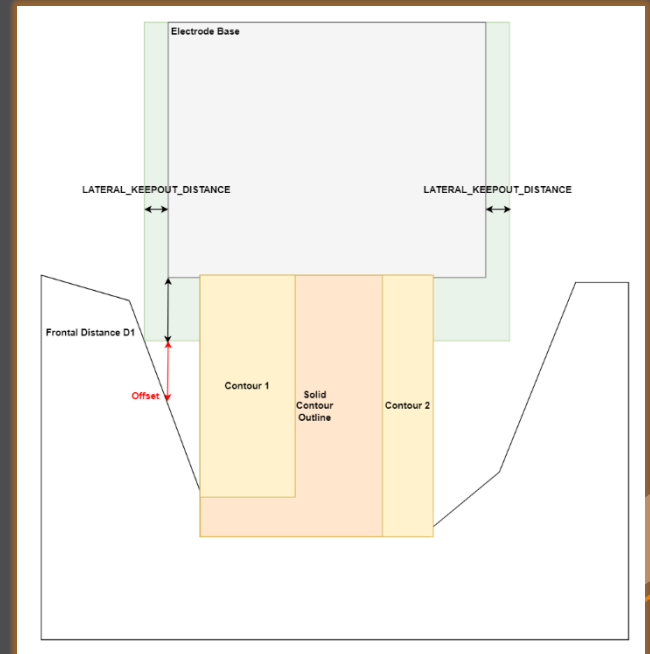

# Enhancement

## What

- Introduce new option #Electrode #SOLID\_CONTOUR\_CLEARANCE  
<https://redmine.buw-soft.de/issues/13765>

## Why

- Necessary to specify the minimum clearance in XY direction between the contour and blank outline

## How

- Option value SOLID\_CONTOUR\_CLEARANCE defines the clearance added to electrode's solid contour before blank size selection.
- Default value '0'

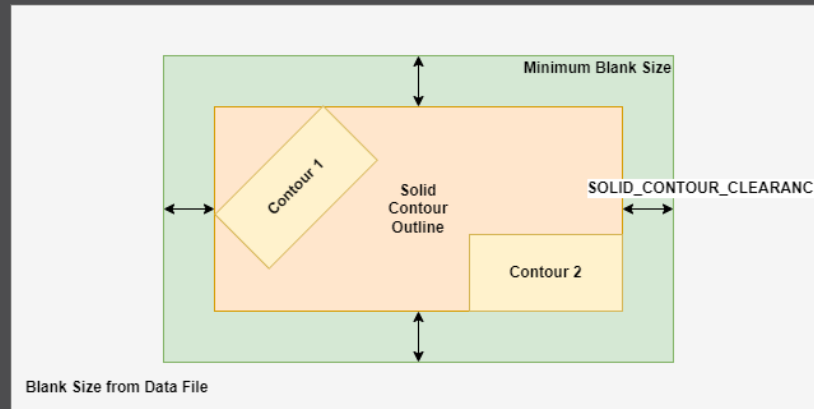

# Improvement

## What

- Allow enabling or disabling automatic calculation of a variable measure in the Base UI. <https://redmine.buw-soft.de/issues/13672>
- (related to: <https://redmine.buw-soft.de/issues/12517>)

## Why

- Allows users to switch between both behaviors

## How

1. **Variable dimension used (-1)**  
Variable dimension will be disabled and calculated automatically based on other inputs.
2. **Blank unlocked**  
Z position of blank length should stay fixed on input.  
Change of D2 changes D2 and D3.  
Change of Z position changes LENGTH and D3 accordingly.  
Change of LENGTH changes LENGTH and D3 accordingly.
3. **Blank locked**  
Blank (A\_BASE, B\_BASE, LENGTH and D2) are disabled and can't be changed. Changes to D1, D3 or Z position change the other two dependent values accordingly.

**Blank**

Type: RECTANGULAR\_BASE\_FRAME

Size: 15X15

Locked:  Blank  Free Dim

A\_BASE: 15.000 D1: 5.128

B\_BASE: 15.000 D2: 22.000

Length: 30.000 D3: 0.022

Chamfers:  1.000  0.200

Frame:  5.000  1.000

**Blank**

Type: RECTANGULAR\_BASE\_FRAME

Size: 15X15

Locked:  Blank  Free Dim

A\_BASE: 15.000 D1: 5.128

B\_BASE: 15.000 D2: 22.000

Length: 30.000 D3: 0.022

Chamfers:  1.000  0.200

Frame:  5.000  1.000

**Blank**

Type: RECTANGULAR\_BASE\_FRAME

Size: 15X15

Locked:  Blank  Free Dim

A\_BASE: 15.000 D1: 5.128

B\_BASE: 15.000 D2: 22.000

Length: 30.000 D3: 0.022

Chamfers:  1.000  0.200

Frame:  5.000  1.000



# Enhancement

## What

- Allow export of files for Creo View  
<https://redmine.buw-soft.de/issues/13699>

## Why

- Provide data for downstream processes

## How

- Use keywords “SE\_EDM\_BACKUP\_PVS” or “SE\_EDM\_BACKUP\_PVZ” in export template to create a file structure for Creo View (PVS) or a zipped archive of the files (PVZ). PVS creates a \*.pvs for the file structure and numerated \*.ol files containing viewable geometry.
- Example: export PVS/PVZ of assembly

```
Assembly PVS: #SE_EDM_BACKUP_DIR#\#partname#. #SE_EDM_BACKUP_PVS#  
Assembly PVZ: #SE_EDM_BACKUP_DIR#\#partname#. #SE_EDM_BACKUP_PVZ#
```

- Example: export PVS/PVZ for each electrode

```
ELECTRODE_START  
PVS: #SE_EDM_BACKUP_DIR#\#partname#. #SE_EDM_BACKUP_PVS#  
PVZ: #SE_EDM_BACKUP_DIR#\#partname#. #SE_EDM_BACKUP_PVZ#  
ELECTRODE_END
```

# Enhancement

## What

- Use default profiles or option files for 3D exports  
<https://redmine.buw-soft.de/issues/13681>

## Why

- Support of custom option files

## How

- Save options file named “def\_profile” to export/<type> or processor/<type>.

Type	Keyword in export template	Options file name
VDA	SE_EDM_BACKUP_VDA	def_profile.dep_vda
STEP	SE_EDM_BACKUP_STEP	def_profile.dep_step
IGES	SE_EDM_BACKUP_IGES	def_profile.dep_iges
CATIA	SE_EDM_BACKUP_CATIA	def_profile.dep_catv5
SAT (Acis)	SE_EDM_BACKUP_SAT	def_profile.dep_acis
NEUTRAL	SE_EDM_BACKUP_NEUTRAL	def_profile.dep_neu
X_T (Parasolid)	SE_EDM_BACKUP_X_T	def_profile.dep_para
UG (NX)	SE_EDM_BACKUP_UG	def_profile.dep_nx
JT (license necessary)	SE_EDM_BACKUP_JT	def_profile.dep_jt



# SMARTElectrode 13.0.5.0

*What's New*





# Enhancement

## What

- Introduce SMARTElectrode commands in mini toolbar
- <https://redmine.buw-soft.de/issues/13293>

## Why

- Faster and more intuitive access to commands

## How

- Assembly mode
  - Object window or modeltree / single selection
  - Object window or modeltree / Multiple selections
  - Object window / workpiece faces
  - Operation in modeltree
- Active component
  - Workpiece faces
  - Electrode faces/quilts/one-sided edges
  - Feature in modeltree

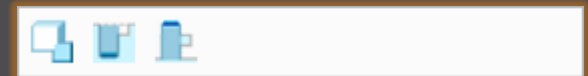



# SMARTElectrode 13.0.4.0

*What's New*



# Enhancement

## What

- Edit properties of multiple objects in user interface
- <https://redmine.buw-soft.de/issues/12842>



Eigenschaften

## Why

- Helpful if especially technology settings have to be updated

## How

- Access Properties UI with several selected objects from modeltree or Burnsheat UI.
- Only parameters available in all objects are are.
- Parameters with different values will be displayed as **<Status quo>**.
- Edited values will be updated for all selected objects.
- Make sure to select all relevant objects before editing.

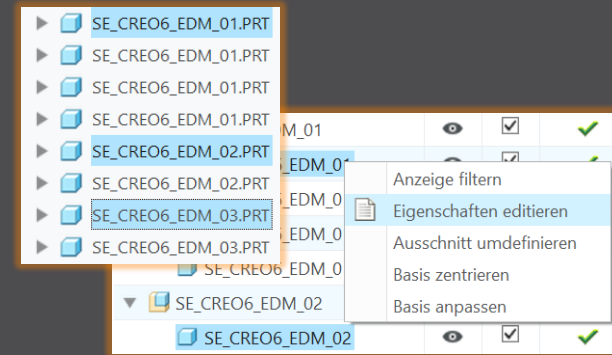

	PRIORITAET	<Status quo>	Very low wear
	BRENNFLAECH	<Status quo>	<Status quo>
	ANZAHL	3	3
	▼	<Status quo>	0.5
	ANZ_UNTERMAS	2	-

# Enhancement

## What

- Overhauled Options UI
- <https://redmine.buw-soft.de/issues/12059>

## Why

- Appearance adjusted to PTC options look & feel

## How

- Only changed values are saved
- Option file includes option value descriptions
- Easier discard and reset to defaults

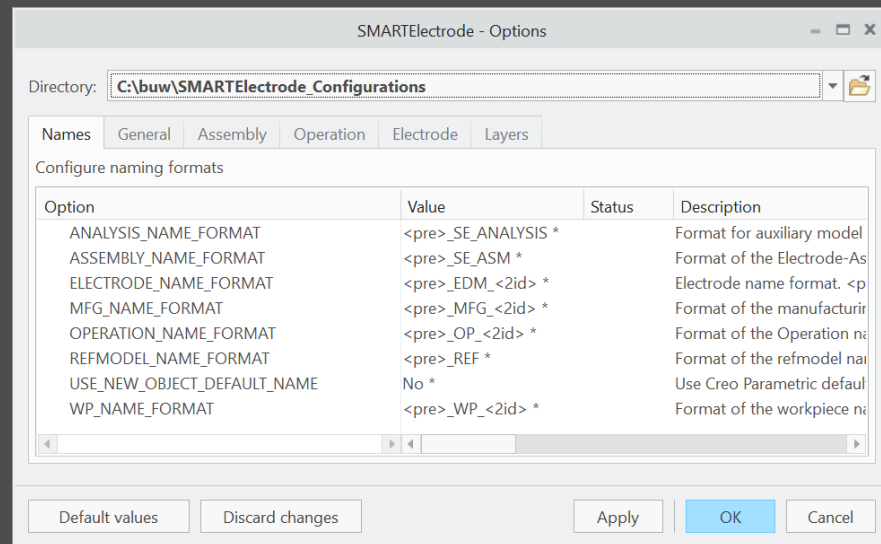



# Improvement

## What

- Base UI - allow overwriting of calculated values.
- <https://redmine.buw-soft.de/issues/12517>

## Why

- Until now base dimensions calculated by SMARTElectrode have been disabled
- In some cases, users still need access to values after SMARTElectrode initially calculated them

## How

All base dimensions are now accessible after SE placed the base group

### 1. Blank unlocked

Keep absolute Z position of blank length. Change of D2 changes LENGTH accordingly to keep position. Change of Z position changes LENGTH accordingly to keep position. Change of LENGTH changes D3 (top offset) accordingly.

### 2. Blank locked

Blank (A\_BASE, B\_BASE, LENGTH and D2) are disabled and can't be changed. Changes to D1, D3 or Z position change the other two dependent values accordingly

**Blank**

LOCKED 

TYPE: RECTANGULAR\_BASE

SIZE: D2\_VARIABEL

A_BASE	15.000	D1	5.150
B_BASE	15.000	D2	42.000
LENGTH	50.000	D3	0.000

**Blank**

LOCKED 

TYPE: RECTANGULAR\_BASE

SIZE: LAENGE\_VARIABEL

A_BASE	15.000	D1	5.150
B_BASE	15.000	D2	20.000
LENGTH	28.000	D3	0.000

# Enhancement

## What

- Edit CMM points in user interface
- <https://redmine.buw-soft.de/issues/12392>

## Why

- Move measuring points to even value

## How

- Open “CMM points”
- Select point to edit in table
- Start edit on double-click or press “Edit”
- Point will be automatically moved to new position or reachable coordinates are suggested if point is out of bounds
- Original coordinates are restored on cancel

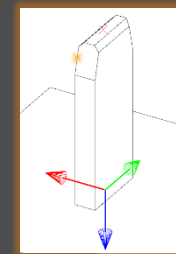
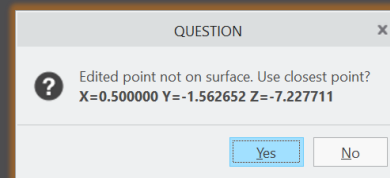
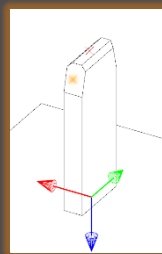
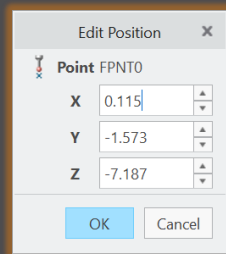

# Enhancement

## What

- Allow CMM points in workpiece models
- <https://redmine.buw-soft.de/issues/12327>

## Why

- Enable definition and output of measuring points for CMM in workpieces

## How

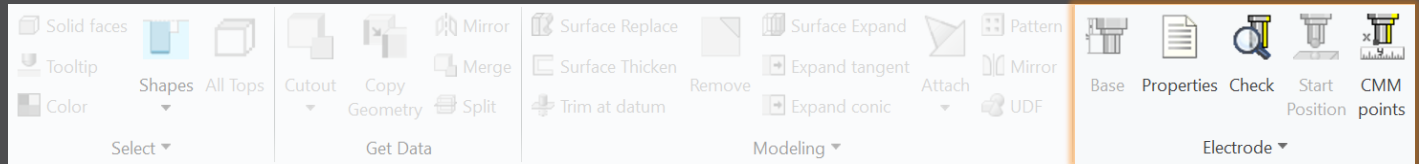

Workflow and functionality is the same as for electrodes

- Activate component
- Open “CMM points”
- “Add” measuring points on pick position till loop is cancelled with MMB
- Confirm or discard points

The screenshot shows a dialog box titled 'Measuring Points' with a table of data. The table has columns for ID, X, Y, Z, I, J, and K. The data is as follows:

ID	X	Y	Z	I	J	K
1	26.17	5.98	2.57	0.81	0.26	0.95
2	29.11	2.26	83.16	0.97	0.99	0.24
3	26.32	2.11	5.24	0.80	1.00	0.85

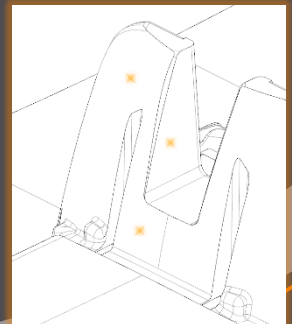

# Improvement

## What

- Measuring points can be added to template.
- <https://redmine.buw-soft.de/issues/11335>

## Why

- For easier measuring of preset

## How

- Each point feature has to carry a parameter "SE\_QMM\_POINTS" for identification.
- Use field points or general datum points.
- General datum point features may include multiple points.
- General datum points can't be edited in UI and are highlighted with a yellow background.
- **Note:** deletion of point in UI always deletes the whole feature.
- Use command "Save custom base" to update templates.

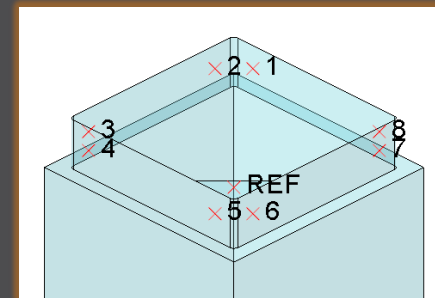

Name	Type	Value
SE_QMM_POINTS	Integer	1

Measuring Points

+ Add Edit X Delete Save

ID	X	Y	Z	I	J	K
1	5.00	6.50	1.50	-0.00	1.00	-0.00
2	6.50	5.00	1.50	1.00	0.00	0.00
3	6.50	-5.00	1.50	1.00	0.00	0.00
4	5.00	6.50	1.50	0.00	1.00	0.00

# Improvement

## What

- Export additional information for quality measuring to Z&K Alphamoduli.
- <https://redmine.buw-soft.de/issues/12839>

## Why

- Enables an easier setup of CMM.

## How

Name	Type	Description	Parameter Rule
TolMin	Float	Allowed lower tolerance for quality measuring	&qm_tol_min
TolMax	Float	Allowed upper tolerance for quality measuring	&qm_tol_max
PresetStylus	Char(32)	Stylus name for preset	&qm_preset_stylus
PresetTip	Char(32)	Tip name for preset	&qm_preset_tip
PresetPrehitDistance	Float	Prehit distance during preset	&qm_preset_prehit
PresetRetractDistance	Float	Retract distance during preset	&qm_preset_retract
QMStylus	Char(32)	Stylus name for measuring	&qm_stylus
QMTip	Char(32)	Tip name for measuring	&qm_tip
QMPrehitDistance	Float	Prehit distance during measuring	&qm_prehit
QMRetractDistance	Float	Retract distance during measuring	&qm_retract

# Improvement

## What

- Introduced workpiece naming format for Z&K Alphamoduli.
- <https://redmine.buw-soft.de/issues/12324>

## Why

- Valid Creo name length of 31 characters may not available depending on EDM setup.
- Allow generation of short workpiece names.

## How

- Use option SE\_CORE\_NAME\_FORMAT to define a format for short names.
- CAD model name is used if options is undefined or empty.
- Any workpiece parameter from configuration can be used in format.
- Example setting in export.cfg:

```
! naming format for workpiece models in XML file  
SE_CORE_NAME_FORMAT WP_<ID>
```

- Result in XML:

```
<LogWrk>  
  <Name>WP_1</Name>  
  <CadModel>.\WORKPIECE\JS748100_AS.STP</CadModel>  
  <Remark>JS748100_AS</Remark>  
</LogWrk>
```

# Improvement

## What

- Automatic creation of dimensions on manufacturing drawing.
- <https://redmine.buw-soft.de/issues/12475>

## Why

- Create a more complete NC drawing.

## How

- Automatically add dimensions on NC drawing sheet similar how it works for electrode part drawings.
- Dimensions are created when drawing is copied from template.
- Edit configuration file `my_drawing_format.cfg` to add dimensions in list.
- Use MFG template name in 1<sup>st</sup> column.
- Refer to <https://www.buw-soft.de/en/news/add-workiece-dimensions-automatically/> for more information.

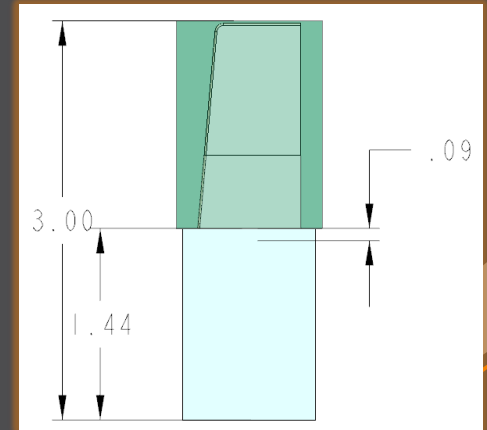
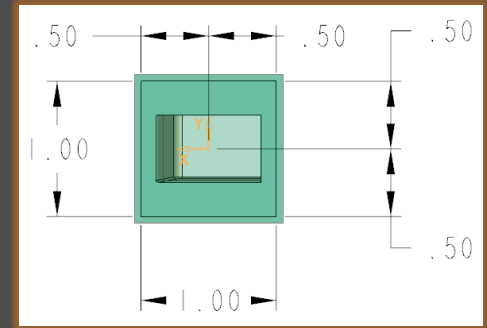

# Improvement

## What

- Drawing UI: new option to add positioning sheet to NC drawing sheet.  
<https://redmine.buw-soft.de/issues/11270>

## Why

- Add electrode position sheet to existing NC drawing sheet similar how it works for electrode part drawings.

## How

- Info: NC drawing sheet can be part of manufacturing template which is assigned in Manufacturing UI and copied during creation of new manufacturing assembly.
- Set option  
MERGE\_EDM\_POSITION\_SHEETS = 5  
to enable this behavior.

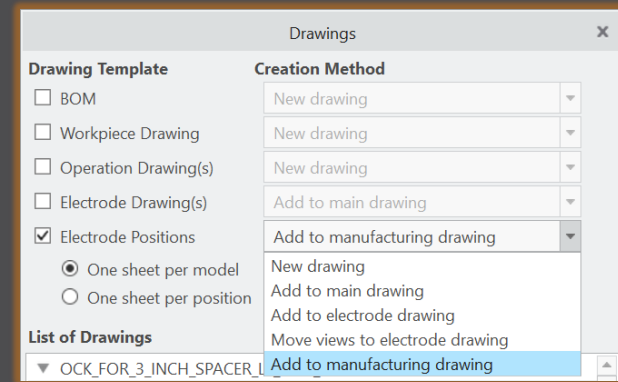



# Fixed error

## Description

- Different behavior for interference check in Creo 4 vs. 6, 7, 8 in active component mode.

- <https://redmine.buw-soft.de/issues/12837>

## Cause

- Current releases of Creo Parametric 6, 7 and 8 **don't** support computation of interferences in active component mode.
- Behavior should be fixed in Creo 7.0.8.0, Creo 8.0.4.0 and Creo 9.0.0.0.
- Error won't be fixed in Creo 6.0.

## Solution

- Interference check will be disabled in active component mode in affected Creo Parametric versions till fix is available.

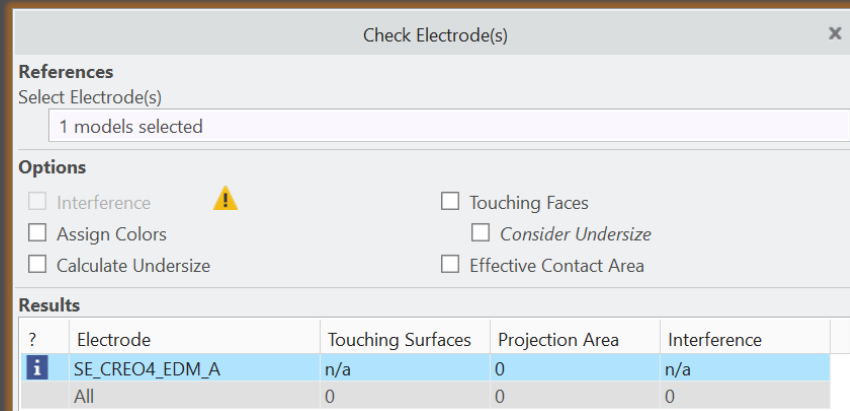

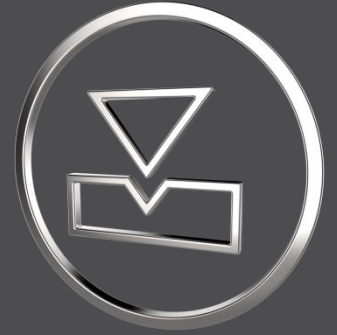

# SMARTElectrode 13.0.3.0

*What's New*



# Enhancement

## What

- Added new command to “Save Custom Base” to save userdefined feature (UDF) and data file for electrode blank.
- <https://redmine.buw-soft.de/issues/12001>

## Why

- New command simplifies creation of customized base and saves a valid data file for it.

## How

- Use command "Open Configuration" to browse to "electrode\*<supplier>*\base\_templates“ and select part to customize.
- Incorporate changes.
- Select "Save Base Template" to create UDF and data file.
- Customize data file.
- Copy UDF and DAT to supplier directory to activate template
- **NOTE:** All variable dimensions to be controlled in data file require a custom symbol name.
- **NOTE:** Open “Getting-Started” document for more information.

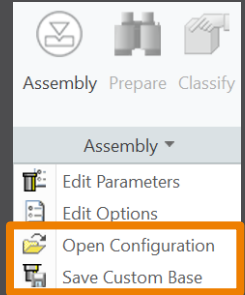

# Enhancement

## What

- Allow additional variable dimensions and parameters in blank data file (\*.dat)
- <https://redmine.buw-soft.de/issues/9953>

## Why

- Customer specific templates sometimes need to control additional dimensions or parameters – for example if holder or order number are part of electrode blank

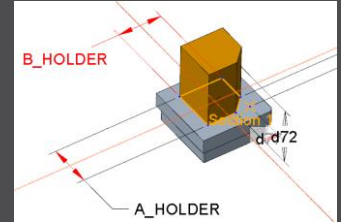

## How

- To use additional parameters with data file an additional line “VALUETYPE” has to be added between “INSTANCE” and blank sizes.

INSTANCE	A_BASE	B_BASE	FRAME_WIDTH	FRAME_HEIGHT	A_HOLDER	B_HOLDER	PARAMINT	PARAMSTRING	PARAMDOUBLE
VALUETYPE	DIM	DIM	DIM	DIM	DIM	DIM	INTEGER	STRING	DOUBLE
E-15-15	15	15	1	3.2	15	15	1515	E-15-15	15.15

- Available types:
  - DIM → Creo dimensions like A\_BASE, B\_BASE, LENGTH, base height D2 and additional dimensions
  - INTERN → internal values used for calculation and advanced settings like D1, D3, MATERIAL, MFG\_TEMPLATE, HOLDER, ...
  - INTEGER → integer parameter
  - STRING → string parameter
  - DOUBLE → double parameter
- **NOTE:** Open “Getting-Started” document for more information

# Improvement

## What

- Adjusted behavior for default values from parameter configuration.
- <https://redmine.buw-soft.de/issues/12025>

## Why

- Until now there have been two different behaviors for default values if...
  - defined in sel\_list.txt or

```
SPARK_MODE ... &priority
```

```
#PRIORITY  
Normal wear  
Low wear  
Normal wear  
High removal
```

- defined in parameter.cfg directly

```
SPARK_MODE ... Normal wear
```

## How

Now in both cases...

- default value defined in parameter.cfg and
- default value defined in sel\_list.txt

...the value from SMARTElectrode configuration will be used now. The value will be set regardless whether the parameter already exists in template for new electrodes or not.

# Improvement

## What

- Check and update mandatory options before drawings are created.

## Why

- Drawing creation may fail if following options can't be set temporarily by SMARTElectrode
  - start\_model\_dir
  - drawing\_view\_origin\_csys
  - drawing\_warn\_if\_flex\_feature
  - save\_display

## How

A warning will be displayed.

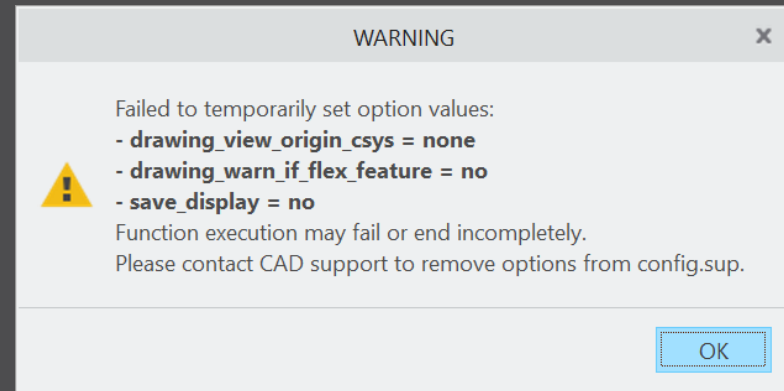

# Fixed error

## Description

- Operations/origins unreadable if group changed.
- <https://redmine.buw-soft.de/issues/12010>

## Cause

- SMARTElectrode expects a fixed sequence order in operation groups:
  - Reference Csys (this is the selected csys)
  - Default Csys (orientation like selected csys on assembly default; used to assemble new electrodes on)
  - Freeface datum plane (default position of electrode base)
  - Default start datum plane (default start position of electrode if not defined otherwise)
  - Default secure datum plane (default secure position of electrode if not defined otherwise)
  - Operation cosmetic for drawing (optional)

## Solution

- SMARTElectrode tries now to identify features in group, but it's still recommended to keep the group unchanged.

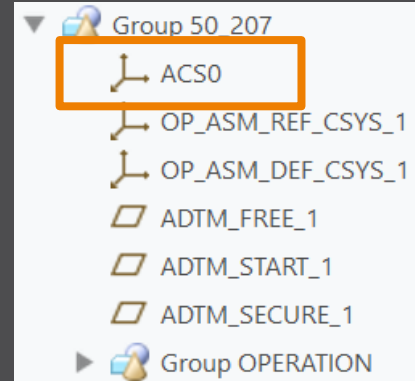



# SMARTElectrode 13.0.2.0

*What's New*

software  
**B&W**



# Enhancement

## What

- Allow surface models as workpieces
- <https://redmine.buw-soft.de/issues/11584>

## Why

- Workpieces are sometimes only available as surface models and can't be repaired via Import Data Doctor (IDD)

## How

- Use method "original models" to create assembly from surface models
- SMARTElectrode offers support for:
  - Workpiece: outline calculation of workpieces
  - Operation: offset calculation in operation definition
  - Design: cutout creates a solid and a solidify feature if referenced workpiece is a surface model. Solidify may fail if quilt includes gaps.
  - Analysis: touching surface analysis for effective contact area
- **NOTE** computation of interference is unavailable for surface models. A warning will be displayed in Check UI

### Interference

⚠ Workpiece TUTORIAL3\_OFFEN is surface model. No calculation possible!

⚠ Workpiece TUTORIAL3\_OFFEN is surface model. No calculation possible!

# Enhancement

## What

- Introduced layer definition in my\_drawing\_format.cfg to control display status
- <https://redmine.buw-soft.de/issues/10575>

## Why

- It's a tedious task to set correct layer display on electrode drawings

## How

- Add section enclosed with .BEGIN\_LAYERS and .END\_LAYERS to my\_drawing\_format.cfg
- Define drawing template name, view, layer and display status in a tab separated table
- Drawing name from configuration\templates: asm\_bom, asm\_wp, asm\_operation, asm\_edm, edm\_default
- View to assign layer setting to. Use VIEW name to set display of layer in a specific view. Use TOP\_MODEL to set display of layer on drawing sheet.
- Layer name whose display status is to be set
- Display status: Set YES to show layer; Set NO to hide layer

# Enhancement

## What

- Electrode base can now also be added on a user-defined coordinate system
- <https://redmine.buw-soft.de/issues/8704>

## Why

- To lock the position of the base on an axis
- To prepare a geometry pattern of the contour

## How

- Define coordinate system in electrode
- Select coordinate system and open Base UI
  - Base will be added to coordinate system
  - Position of coordinate system is taken into account to calculate required blank size
- Base is locked to coordinate system. Delete base to use different option

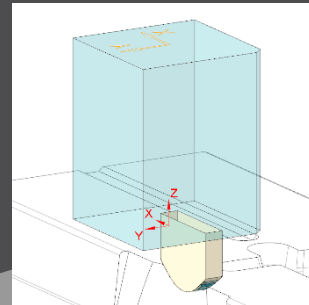
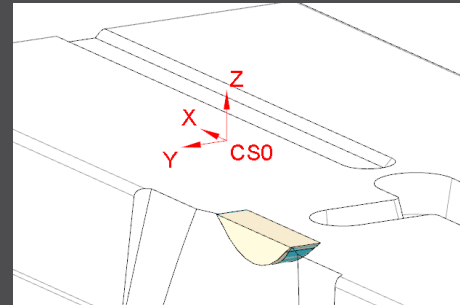
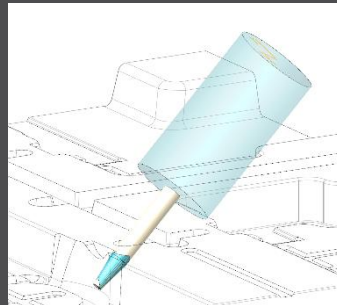
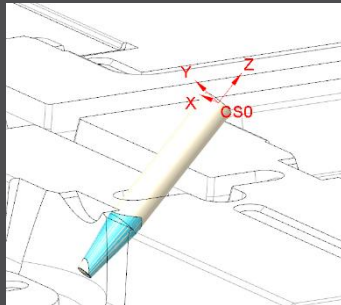

# Enhancement

## What

- Copy electrodes from existing electrodes or prepared templates
- <https://redmine.buw-soft.de/issues/11700>

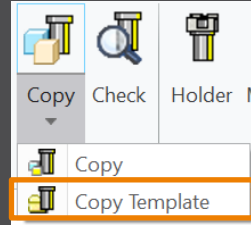

## Why

- Allow reuse of...
  - incomplete electrode models to be completed inside assembly (for gate electrodes)
  - complete electrode models created without SMARTElectrode (for electrodes from stock)
  - complete electrode created with SMARTElectrode (for electrodes from different assembly)

## How

- Csys defined in option SE\_EDM\_ORGIN\_NAME is mandatory
- "configuration\electrode\templates" is used as default path to select templates
- Associated data (drawing, manufacturing) will be copied to new name also
- Controls in Base UI will be disabled if template is detected

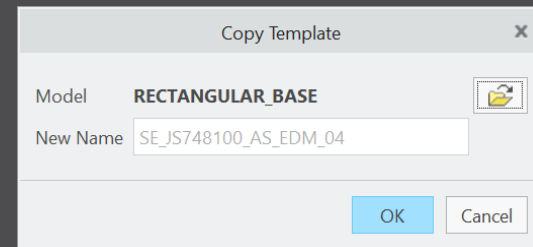

# Improvement

## What

- Electrode design mode:  
Maintain definition of surface collections when creating copy-geoms
- <https://redmine.buw-soft.de/issues/11765>

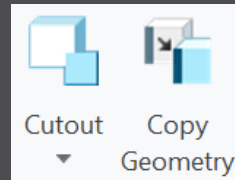

## Why

- So far, a new copy-geom was created for each surface set on >Get Data >Cutout and >Get Data >Copy Geometry

## How

- Surface sets in selection buffer are now automatically sorted by reference model
- All surface sets from same reference model will be added to same copy-geom feature

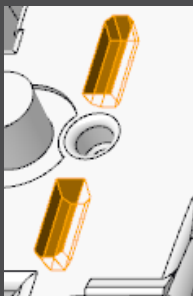

Surface Sets		
Set	Count	
Individual Surfaces	0	Add
Seed and Boundary Surfaces	9	Remove
Seed and Boundary Surfaces	9	
Excluded Surfaces	0	

# Improvement

## What

- Base UI - keep predefined holder offset if different holder is selected on details page
- <https://redmine.buw-soft.de/issues/10943>

## Why



- Adapts behavior of Base UI to Holder UI. Offset / rotation will be retained if a different holder is selected

## How

- Selection of new blank type or size updates holder and position

	25X85X60_025MM
B_BASE	25X85X60_100MM
	35X35X60
LENGTH	35X35X60_025MM_1
CHAMFER	35X35X60_025MM_2

- Current position will be retained if a new model is selected on details page

Holder	
Supplier	EROWA
Type	F60000
	 Edit Position
	 Reset Position

- A new popup menu allows edit and reset of holder position

# Interface to Ingersoll MultiProg

## What

- Suppress output of generator types to ING file
- <https://redmine.buw-soft.de/issues/10943>

## Why

- Set undersize values are mapped on generator types in output
- Some customers prefer output without generator types

	Undersize	Quantity
▼	0.5	2
▼▼	0.4	1
▼▼▼	0.30	1
▼▼▼▼	0.20	1

## How

- Add option WRITE\_GENTYPEL NO to export.cfg to suppress output  
`WRITE_GENTYPEL · NO`
- File is located in configuration\processor\INGERSOLL\pp\export.cfg
- Generator types based on undersize values
  - RO: roughing
  - PF: prefinish
  - FI: finish
  - FF: fine finish

# Interface to ZK Alphamoduli

## What

- Calculate <SafetyDistance> based on electrode contour height and position of MEASZPOINT

- <https://redmine.buw-soft.de/issues/11881>

## Why

- <SafetyDistance> uses a fixed value from export.cfg currently
- A calculation based on contour height is necessary

## How

- Two options in export.cfg control behavior for <SafetyDistance>
  - SafetyDistance ... → fixed to be considered at the CMM.
  - SafetyDistanceOffset ... → offset for safety distance added to measured distance from blank length to MeasZPoint

- **Note**  
Only use SafetyDistance or SafetyDistanceOffset!

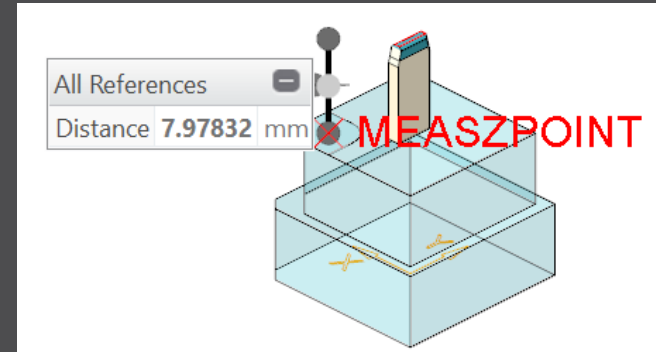



# Interface to ZK Alphamoduli

## What

- Allow alternative csys for output of measure information
- <https://redmine.buw-soft.de/issues/11585>

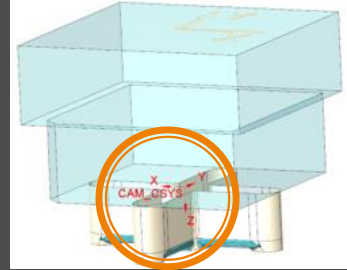
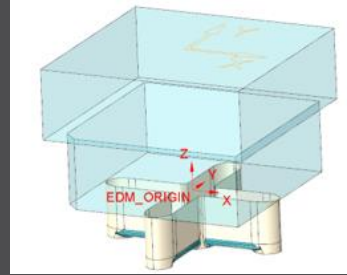

## Why

- All measuring information like

```
<MeasSizeX>38.0000</MeasSizeX>  
<MeasSizeY>38.0000</MeasSizeY>  
<MeasSizeZ>0.0000</MeasSizeZ>  
<MeasZPointX>-16.5000</MeasZPointX>  
<MeasZPointY>-16.5000</MeasZPointY>  
<MeasZPointZ>0.0000</MeasZPointZ>  
<QMPoint>  
...  
</QMPoint>
```

- ... need to be output for csys with correct orientation
- Use setting “SE\_EDM\_BACKUP\_CSYS” in export.cfg to set csys names
- Several alternative csys can separated by ;
- Option names will automatically be replaced by value

## How

```
SE_EDM_BACKUP_CSYS · EL_CSYS; · CSYS_DEFAULT; · ANY_CSYS;  
SE_EDM_BACKUP_CSYS · CAM_CSYS_NAME; · EDM_ORIGIN_NAME;
```

# Interface to ZK Alphamoduli

## What

- Add <MeasureProg> to XML output
- <https://redmine.buw-soft.de/issues/11659>

## Why

- MeasureProg is the name of the learning/measuring program for the automatic presetting at the CMM

## How

- A measure frame needs to be available to output <MeasureProg>
- Default values are:

```
<!-- default for rectangular frame: ESVierkant -->  
<MeasureProg>ESVierkant </MeasureProg>  
<!-- default for round frame: ESMitteKreis -->  
<MeasureProg>ESMitteKreis</MeasureProg>
```

- Custom names for <MeasureProg> can be defined in parameters
  - Parameter configuration  
MEASUREPROG PART STRING N N 10 N Y &measureprog
  - Selection list in sel\_list.txt  
#MEASUREPROG  
...

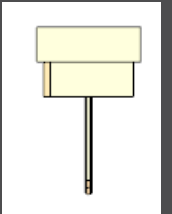
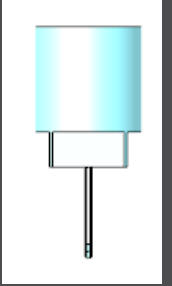

# Interface to ZK Alphamoduli

What

- Suppress `<MeasProgType>` and `<MeasSize...>` if no frame available
- <https://redmine.buw-soft.de/issues/11537>
- <https://redmine.buw-soft.de/issues/11587>

Why

- `<MeasProgType>` and `<MeasSize...>` are only valid if a measuring frame is available in blank
- Output is suppressed if frame is not found

```
<MeasProgType></MeasProgType> > empty  
<MeasSizeX></MeasSizeX> > skipped  
<MeasSizeY></MeasSizeY> > skipped  
<MeasSizeZ></MeasSizeZ> > skipped
```

- Example electrodes without frames:

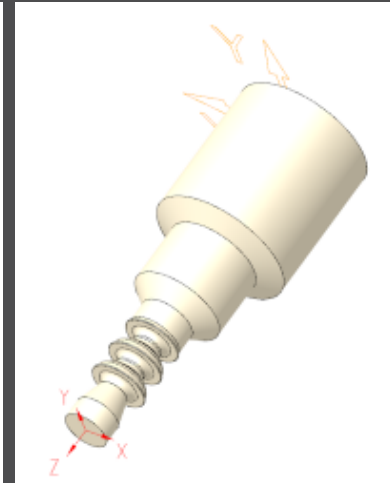
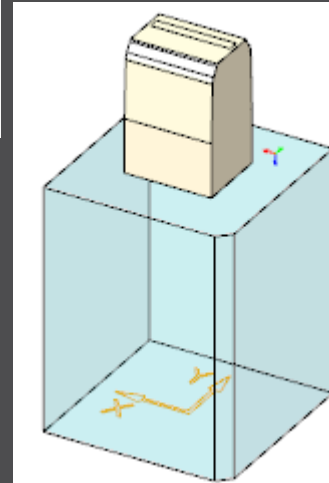

# Interface to ZK Alphamoduli

## What

- Allow custom name for MeasZPoint in export settings
- <https://redmine.buw-soft.de/issues/11586>

## Why

- MeasZPoint is the datum point where Z-height should be measured
- Datum point may be available in customer templates with different name

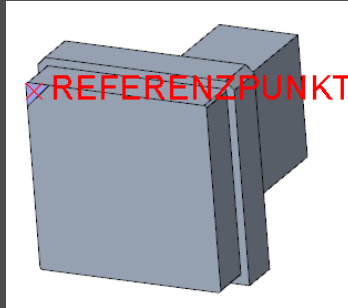

## How

- Add option MeasZPoint <name> to export.cfg
  - An existing datum point named “MEASZPOINT” will be renamed on export
- ```
! · name · of · datum · point · feature · to · use · for · MeasZPoint  
MeasZPoint · MEASZREF
```
- **NOTE** Datum point needs to be reachable!

# Interface to ZK Alphamoduli

## What

- Name format options to shorten names in XML output
- <https://redmine.buw-soft.de/issues/11855>

## Why

- Depending on EDM machine setup length of 32 characters may **not** be available for electrode names in XML
- Creation of shorter names is required

## How

- Naming options SE\_EDM\_NAME\_FORMAT and SE\_2<sup>ND</sup>\_EDM\_NAME\_FORMAT introduced. Examples:
  - SE\_EDM\_NAME\_FORMAT EDM\_<ID>
  - SE\_2<sup>ND</sup>\_EDM\_NAME\_FORMAT <partname><any known parameter>

```
<LogEle LogGroup=„SE_EDM_NAME_FORMAT“>
  <Name>SE_EDM_NAME_FORMAT</Name>
  <Remark>SE_2ND_EDM_NAME_FORMAT</Remark>
  <DocList>
    <Document>
      <Name>SE_2ND_EDM_NAME_FORMAT</Name>
      <File>SE_2ND_EDM_NAME_FORMAT</File>
    </Document>
  </DocList>
</CadModel>SE_2ND_EDM_NAME_FORMAT</CadModel>
```

# Fixed Error

## What

- Assignment of combined states to drawing views fails sometimes
- <https://redmine.buw-soft.de/issues/10772>

## Resolution

- Replaced combined states with a list of layer definitions which can be controlled independently from 3d model
- Details [here](#)

### Enhancement

What	<ul style="list-style-type: none"><li>• Introduced layer definition in <code>my_drawing_format.dwg</code> to control display status</li><li>• <a href="https://redmine.buw-soft.de/issues/10772">https://redmine.buw-soft.de/issues/10772</a></li></ul>
Why	<ul style="list-style-type: none"><li>• It's a tedious task to set correct layer display on electrode drawings</li></ul>
How	<ul style="list-style-type: none"><li>• Add section enclosed with <code>BEGIN_LAYERS</code> and <code>END_LAYERS</code> to <code>my_drawing_format.dwg</code></li><li>• Define drawing template name, view, layer and display status in a tab separated table</li><li>• Drawing name from configuration/templates: <code>asm_bom</code>, <code>asm_up</code>, <code>asm_operation</code>, <code>asm_edm</code>, <code>edm_default</code></li><li>• View to assign layer setting to. Use VIEW name to set display of layer in a specific view. Use <code>TOP_MODEL</code> to set display of layer on drawing sheet.</li><li>• Layer name whose display status to to be set</li><li>• Display status: Set YES to show layer; Set NO to hide layer</li></ul>

# Fixed Error

## What

- Command “Attach” fails for quilts with multiple contours
- <https://redmine.buw-soft.de/issues/11708>

## Why

- Starting edges of the boundary loops are not found correctly

## Resolution

- Issue is fixed

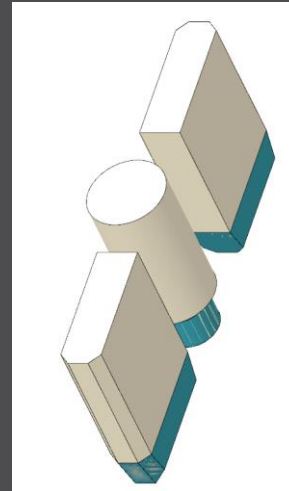
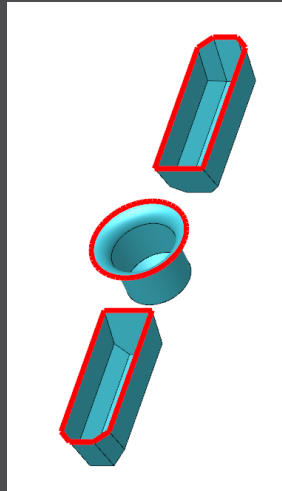
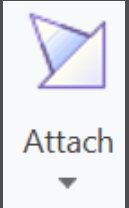

# Fixed Error

## What

- Project UI - skip models without solids during project creation
- <https://redmine.buw-soft.de/issues/11548>

## Why

- Regeneration error occurs if copy-geom, inheritance or merge feature is created for a model without solid geometry

## Resolution

- Models without solid will be skipped during creation of reference part
- An error message will be displayed

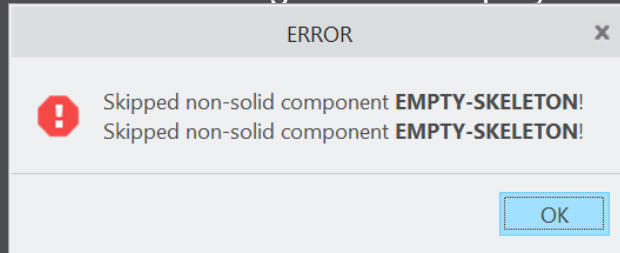





# SMARTElectrode 13.0.1.0

*What's New*



# Improvement

## What

- All configuration files are now considered as encoded in UTF-8
- <https://redmine.buw-soft.de/issues/10943>

## Why

- Necessary for updated interfaces to EDM

## How

- Please use a tool like Notepad++ to convert if necessary
- Files using ASCII standard characters don't need any special handling

# Improvement

## What

- Introduced 'Getting started' document
- <https://redmine.buw-soft.de/issues/10749>

## Why

- This document explains briefly how to start working with SMARTElectrode

## How

- Open 'Getting started' from
  - Installation directory
  - Download server:  
<https://dl.buw-soft.de/smartelectrode/guides/getting-started.pdf>
- Some of the topics covered
  - Configure license / Register and start SE
  - Setting up a configuration / How to use setup wizard
  - Creo options / SMARTElectrode Options
  - Workflow in SMARTElectrode
  - Parameters
  - Base UI
  - Customizing electrode templates
  - Drawing Creation

# Enhancement

## What

- Sort electrodes by parameter value before export
- <https://redmine.buw-soft.de/issues/10575>

## Why

- Some customers need to output electrodes in a specific sort order

## How

- Two new keywords can be used in any export configuration (export.cfg)
  - SE\_ORDER\_BY  
Define parameter by parameter name (1<sup>st</sup> column) or parameter default (last column; include &)
  - SE\_SORT\_ORDER  
Defines sort order: ASC, ASCENDING, DESC, DESCENDING
- Sorting works for strings, doubles and integers
- Only sort by part parameters!

```
SE_ORDER_BY · &BURNAREA_XY  
SE_SORT_ORDER · DESCENDING
```

```
SE_ORDER_BY · BRENNFLAECHE  
SE_SORT_ORDER · DESCENDING
```

```
BURNAREA · ID · NAME  
361.980 · 11 · JS748100_AS_EDM_11  
157.062 · 12 · JS748100_AS_EDM_12  
156.671 · 12 · JS748100_AS_EDM_12  
28.102 · 10 · JS748100_AS_EDM_10  
28.102 · 10 · JS748100_AS_EDM_10  
25.607 · 3 · JS748100_AS_EDM_03
```

# Improvement

## What

- Consider default action (include/exclude) of simplified representation when valid components for export are collected
- <https://redmine.buw-soft.de/issues/11020>

## Why

- Allow usage of master representation for example

## How

- All valid items in simprep are collected automatically by SMARTElectrode

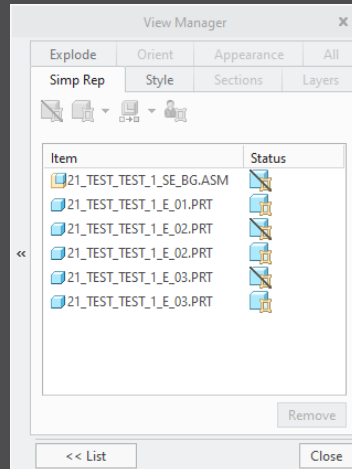

# Improvement

## What

- Updated advanced interface for Zimmer&Kreim Alphamoduli
- <https://redmine.buw-soft.de/issues/7864>

## How

- Processor files include upated list of orbits
- Additional supported XML tags in export
  - MeasDim
  - MeasProgType
  - MeasSizeX
  - MeasSizeY
  - MeasSizeZ
  - MeasZPointX
  - MeasZPointY
  - MeasZPointZ
  - EdgeDistance
  - SafetyDistance
- Please contact us for detailed information and setup!



ZK\_Deutsch.zip



ZK\_English.zip

# Improvement

## What

- Round contour height to even value in Base UI
- <https://redmine.buw-soft.de/issues/5550>

## Why

- For users more interested in an even contour height than in a rounded position

## How

- Mandatory settings:
  - INCREMENT\_POS = 0
  - INCREMENT\_SIZE > 0
- Height of contour will be rounded to a value, where
  - D1 corresponds at least to value in data file
  - D3 corresponds exactly to value in data file
  - Contour height is rounded to INCREMENT\_SIZE
- Should be combined with a free value
  - blank length (LENGTH = -1) or
  - base height (D2 = -1)

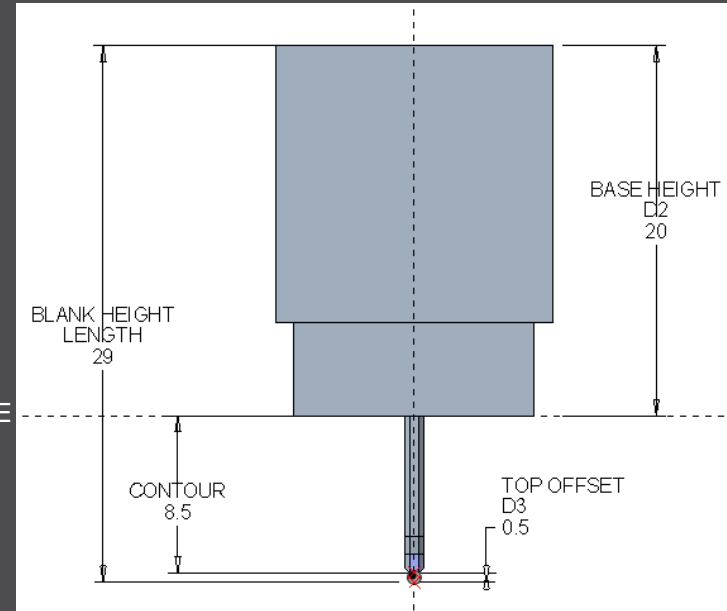

# Improvement

## What

- Show warning in Burnsheat UI if blank length is too small
- <https://redmine.buw-soft.de/issues/8494>

## Why

- Base is **NOT** changed by SMARTElectrode after creation
  - Position of base is retained
  - Size of base is retained
- User is in control whether the base must be revised
- Open Base UI to update values interactively
- Suppress base before Base UI is opened  
→ this starts automatic check and adjustment again

## How

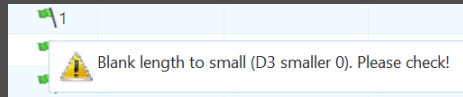

A_BASE	15.000		D1	1.000
B_BASE	15.000		D2	34.000
LENGTH	37.155		D3	-0.700
CHAMFER	<input type="checkbox"/>	Blank length to small (D3 smaller 0). Please check!		
FRAME	<input checked="" type="checkbox"/>	3.200		1.000



# Improvement

## What

- Burnsheet UI / Output UI: electrodes are ordered by feature number per default
- <https://redmine.buw-soft.de/issues/10409>

## Why

- A distinctive electrode sequence is necessary for the output occasionally

## How

- Change order of electrodes in modeltree using drag and drop
- The first appearance of an electrode determines the order for the output

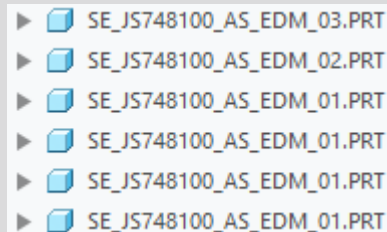

Order in modeltree

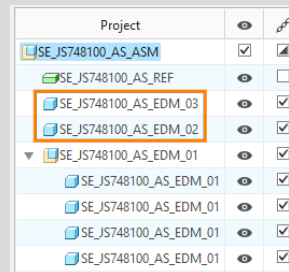

Order in Burnsheet UI

# Improvement

## What









- Show notifications for Burnsheat UI node on mouse-over
- <https://redmine.buw-soft.de/issues/10421>

## Why

- As a quick information for the user

## How

- Move mouse cursor over node if notifications available
- Click on notification to open detailed description in separate window and filter display

Project			Status
 38177-20_SE_BG	<input checked="" type="checkbox"/>	<input checked="" type="checkbox"/>	
 38177-20_SE_REF	<input type="checkbox"/>	<input type="checkbox"/>	
 38177-20-061	<input type="checkbox"/>	<input type="checkbox"/>	 1

 Base not centered on solid.

# Improvement

## What

- Use blank dimensions A\_BASE and B\_BASE for coverage check
- <https://redmine.buw-soft.de/issues/10622>

## Why

- CONTACT\_AREA\_MAX\_COVERAGE defines valid percentage of coverage
- SMARTElectrode used area of 'BASE\_TOP' leading to too small areas if clamp is part of electrode

## How

- SMARTElectrode evaluates blank area by base dimensions if available
- 'BASE\_TOP' surface may be used for imported electrodes
- More information about check for calculated burnarea projection:  
<https://redmine.buw-soft.de/issues/10622>

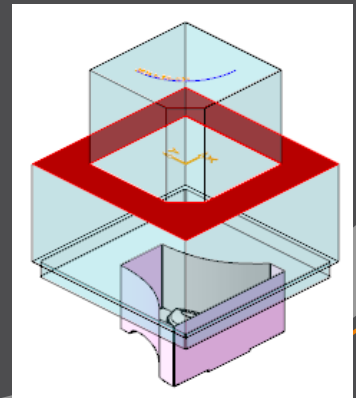

# Improvement

## What

- Allow cancelation of exact burnarea analysis on ESC
- <https://redmine.buw-soft.de/issues/10504>

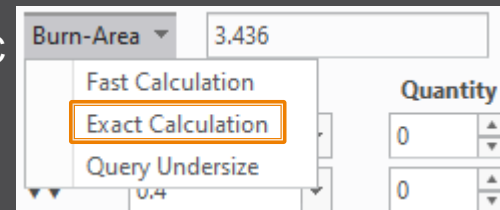

## Why

- Some surface types lead to lengthy analyzes

## How

- Press **ESC** during analysis in Base or Check UI to cancel calculation

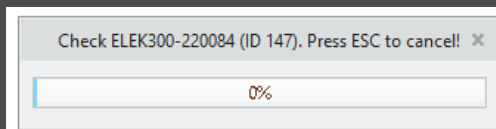

Options				
<input type="checkbox"/>	Interference	<input checked="" type="checkbox"/>	Touching Faces	
<input type="checkbox"/>	Assign Colors	<input type="checkbox"/>	Consider Undersize	
<input type="checkbox"/>	Calculate Undersize	<input checked="" type="checkbox"/>	Effective Contact Area	
Results				
?	Electrode	Touching Surface	Projection Area	Interference
<b>i</b>	SE_JS748100_AS_EDM_01		3.18557	✓
<b>i</b>	SE_JS748100_AS_EDM_01		3.18557	✓
<b>i</b>	SE_JS748100_AS_EDM_01		3.18557	✓
<b>i</b>	SE_JS748100_AS_EDM_01		3.18557	✓
<b>i</b>	SE_JS748100_AS_EDM_02	Cancelled	0	✓
	All	36	12.7423	0

# Improvement

## What

- Allow adjustment of assembly accuracy if inconsistent values are found
- <https://redmine.buw-soft.de/issues/10414>

## Why

- Same accuracy and type should be used in complete assembly
- Inconsistent accuracies may lead to errors

## How

- Warning will be displayed in assembly UI
- Input will be preset to smallest accuracy found
- Additional warning will be shown before creation of reference model
- Errors will be displayed afterwards
- **NOTE** SMARTElectrode does not change accuracy of the original models! This is because SE can't evaluate if change of accuracy is allowed.

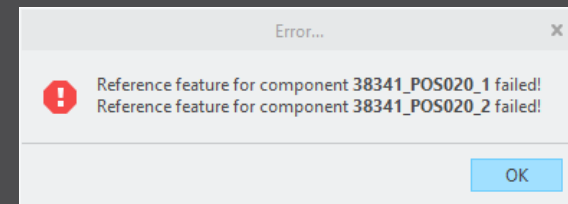
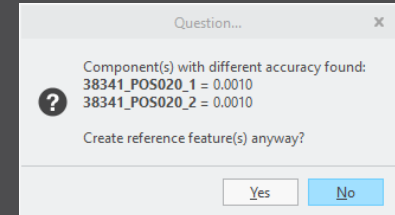
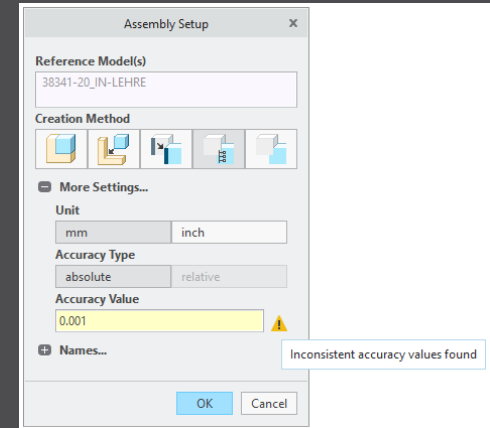

# Improvement

## What

- Use Flexible Modeling 'Substitute' in 'ATTACH' instead of replace
- <https://redmine.buw-soft.de/issues/8703>

## Why

- Normal offset-replace (modeling tab) does sometimes **NOT** unite electrode contour and electrode base, no matter whether FREE\_FACE or solid surface is selected as reference.

## How

- SMARTElectrode automatically uses feature substitute in group 'ATTACH' instead of offset/replace if license for Flexible Modeling Extension is available

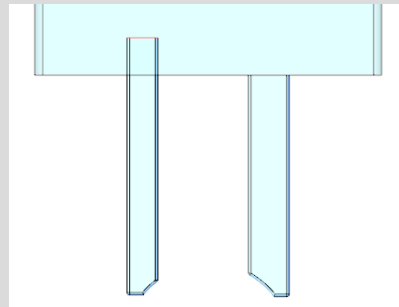

Result for expand

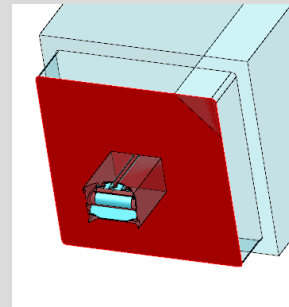

Result for replace

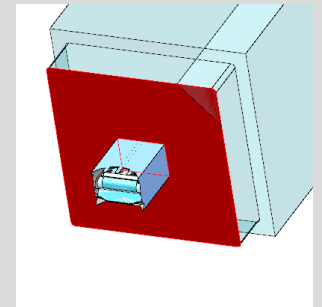

Result for FMX substitute

# Improvement

## What

- Handle existing base for commands 'Pattern' and 'Mirror' in design mode
- <https://redmine.buw-soft.de/issues/8495>



## Why

- Mirror of complete electrode including base may remove chamfers

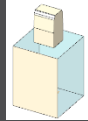

## How

- Command 'Pattern' automatically collects all solid surfaces or surfaces below FREE\_FACE

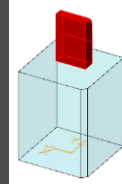

- Command 'Mirror' automatically activates insert mode and adds mirror feature in front of base

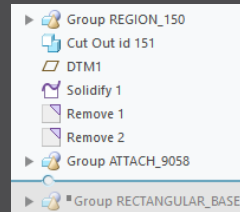

# Improvement

## What

- New commands 'Open Drawing' and 'Open Manufacturing' added to context menu in modeltree and object window
- <https://redmine.buw-soft.de/issues/10411>

## Why

- Easier navigation in electrode assembly

## How

- Commands are only accessible when assembly is active
- Commands are accessible for selected electrode in modeltree and graphics window
- Drawing and manufacturing will be opened in a new window
- If electrode is part of assembly drawing then correct sheet will be shown

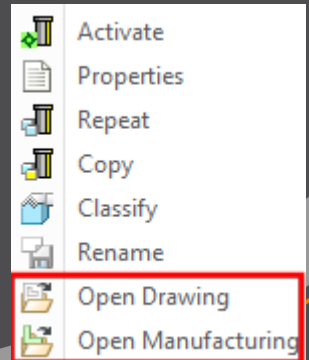



# Improvement

## What

- Introduced new command 'Open Configuration'
- <https://redmine.buw-soft.de/issues/10739>

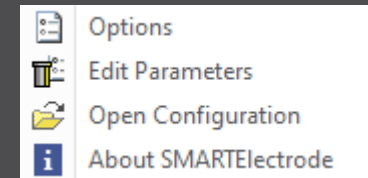

## Why

- Easier access to active configuration

## How

- A file browser opens in active configuration folder
- Actions for selected files / file types
  - parameter.cfg  
Dialog for modification will be opened
  - options.cfg  
Dialog for modification will be opened
  - \*.prt, \*.asm, \*.drw  
Creo file will be opened in a new window
  - any other file  
File will be opened in info window

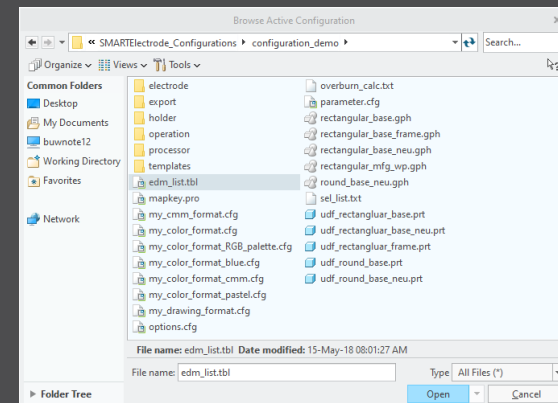

# Improvement

## What

- Disable automatic update of csys on workpiece sides
- <https://redmine.buw-soft.de/issues/10511>

## Why

- User should be in control when dependent operations and electrodes are updated

## How

- The 8 datum points represent the corners of the workpiece outline and can be used for drawing dimensions. These will be updated automatically!
- A notification will be shown in Burnsheat UI for outdated csys
- Double-click in notification details to update csys, operation and electrodes

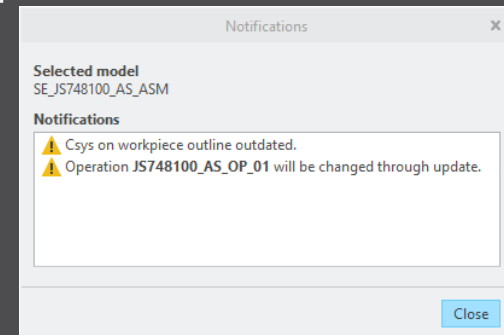
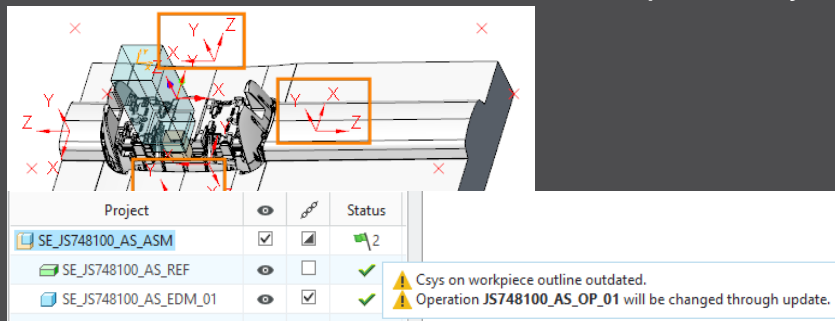
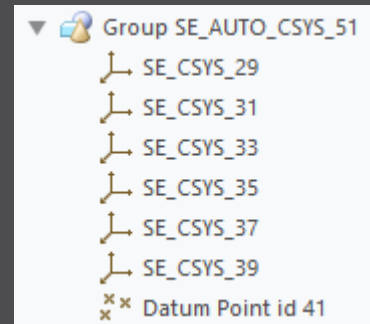

# Improvement

## What

- Repeat UI: only show selected electrodes and preview components when defining new position.
- <https://redmine.buw-soft.de/issues/10399>

## Why

- Improve overview for users if there are many electrodes assembled

## How

- Pre-select electrodes before Assemble Again UI is opened
- Or select in UI (don't forget to confirm selection)
- All electrodes are displayed again on OK or when user starts selection again

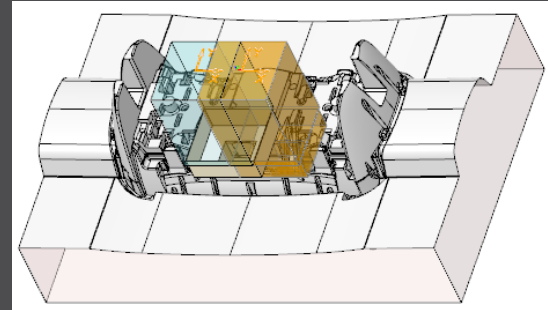
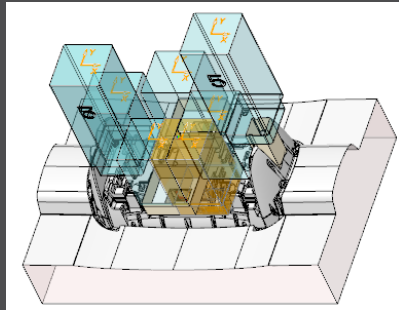

# Improvement

## What

- Use default csys from base to calculate angles
- <https://redmine.buw-soft.de/issues/10822>

## Why

- In some cases, it may be necessary to rotate csys with EDM\_ORIGIN\_NAME
- Angles in burnsheet would appear with wrong values
- Use csys showing orientation of blank for calculation of angles
- Always use 'EDM\_ORIGIN' for electrodes designed in SMARTElectrode 7.0
- Use csys 'SE\_EDM\_BASE' or csys defined in option 'EDM\_ORIGIN\_NAME' for electrodes designed in SMARTElectrode 8.0 – 13.0

## How

- This allows adjustment of csys 'EDM\_ORIGIN\_NAME' for easier definition of start position

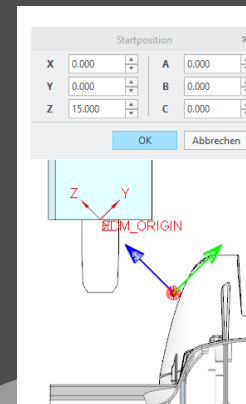
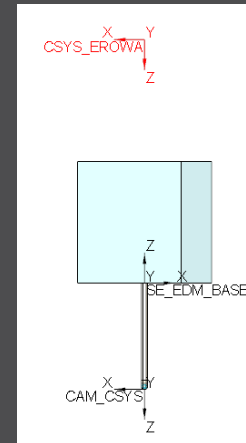

# Improvement

## What

- Allow subgroups in definition of user-defined features for electrode base.
- <https://redmine.buw-soft.de/issues/10389>

## Why

- Sometimes features are nested in groups (MEASURE\_FRAME, FRONT\_NUMBER, FREE\_FACE\_NUMBER) in Base UDF
- These features are currently not considered as part of the base leading to wrong size calculation
- SMARTElectrode now checks all features in base group when checking if a feature/surface is part of base or not.

## How

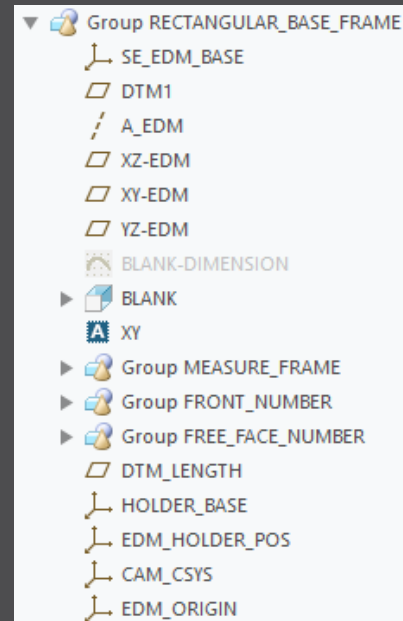

# Improvement

## What

- Check if feature merge in group 'Attach' creates a closed quilt if performed on surface feature or quilt

## Why

- Sometimes merge sets wrong side for 2<sup>nd</sup> quilt to keep
- Leads to an opened quilt which can't be solidified

## How

- SMARTElectrode checks if merge leads to a closed quilt
- SMARTElectrode changes side to keep in merge feature if necessary

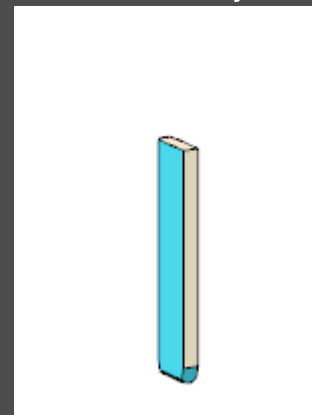
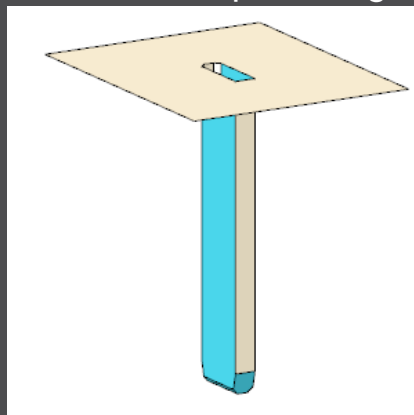
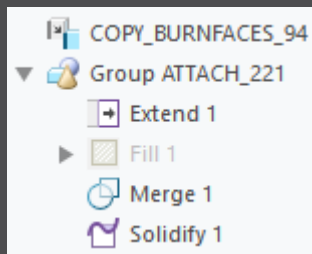

# Fixed Error

## What

- Prevent deletion of active operation
- <https://redmine.buw-soft.de/issues/10733>

## Why

- SMARTElectrode ribbon is disabled after deletion of active operation
- Most of the commands are still accessible but won't work anymore

## Resolution

- SMARTElectrode checks features whether they belong to active operation before deletion
- Deletion will be canceled with message window if feature of active operation selected

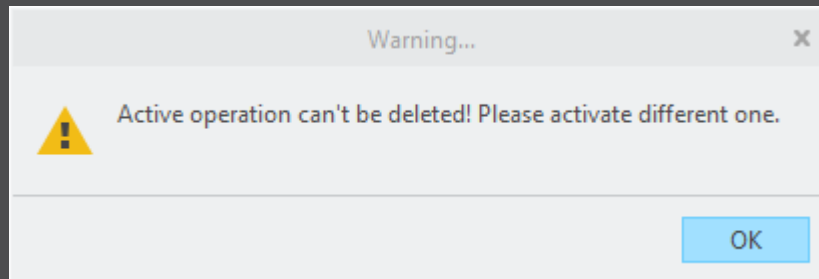

# Fixed Error

## What

- Electrode base with user-defined FREE\_FACE is suppressed to make design changes
- Base is reset to default position when resumed in Base UI

## Why

- Information about user-defined FREE\_FACE gets lost
- SMARTElectrode carries out default process to update base

## Resolution

- SMARTElectrode checks reference of datum FREE\_FACE for changes
- Recognition works for all models with user-defined FREE\_FACE

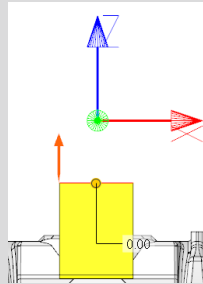

Selected user-defined  
FREE\_FACE

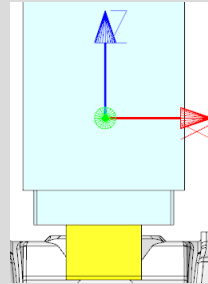

Error on resume in Base  
UI

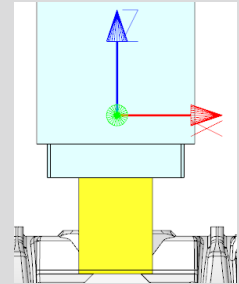

Fix: position is retained



# Fixed Error

## What

- Workpiece dimensions on drawing sometimes incomplete
- <https://redmine.buw-soft.de/issues/10990>

## Why

- Orientations are sometimes not correctly set after drawing creation from template
- For these drawing views sorting of outline points might fail

## How

- Supported symbolic names for drawing orientations
  - 2d view names: SE\_TOP (SE\_DEFAULT), SE\_BOTTOM, SE\_FRONT, SE\_BACK, SE\_LEFT, SE\_RIGHT
  - 3d view names: SE\_DEFAULT\_ISO, SE\_ASM\_DEFAULT, SE\_ASM\_ISO
- Please refer to 'Getting started' document in installation for more information

# Fixed Error

## What

- Fixed wrong creation of ordinate dimensions on drawings
- <https://redmine.buw-soft.de/issues/10685>

## Why

- Multiple redundant baselines without merging dimensions have been created

## How

- This issue is fixed

# Fixed Error

## What

- Reset surface appearance to default before touching faces are colored
- <https://redmine.buw-soft.de/issues/10405>

## Why

- Reset of surface colors is not applicable in all cases

## How

- COLOR\_EDM\_TOUCHING\_FACES has to be available in my\_color\_format.cfg
- A warning will be displayed if 'COLOR\_EDM\_TOUCHING\_FACES' is not applicable
- A distinction is made between the following cases:
  - Check UI: coloring can be done when all electrode positions are selected for touching surface analysis
  - Check UI: a warning will be displayed and coloring will be canceled if NOT all electrode positions are selected for touching surface analysis
  - Base UI: coloring can be done in detailed calculation of contact area if active electrode is used only once in assembly
  - Base UI: a warning will be displayed and coloring will be canceled if active electrode is used multiple times in assembly

# Fixed Error

What

- Fixed wrong result for selection by color
- <https://redmine.buw-soft.de/issues/10857>

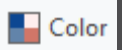

Why

- Sometimes too many surfaces have been selected

Resolution

- This issue is fixed

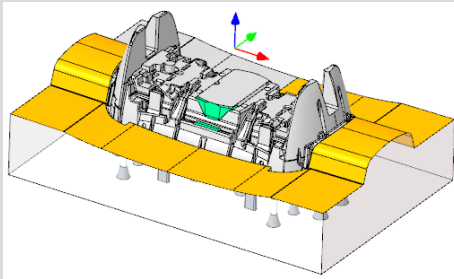

Original

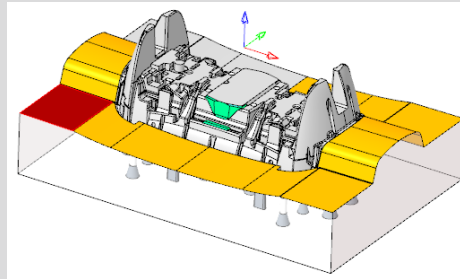

Selected reference

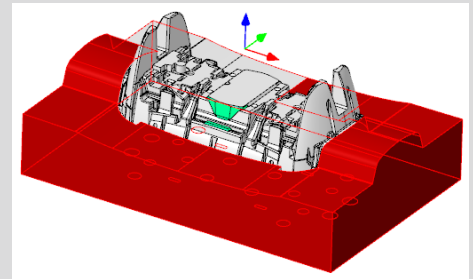

Wrong result

# Fixed Error

## What

- Hide invalid commands in modeltree
- <https://redmine.buw-soft.de/issues/10985>

## Why

- Some commands are invalid in modeltree context menu if selected feature is not inside active component

## How

- This issue is fixed

# Fixed Error

## What

- Commands can be selected from context menu for suppressed electrodes
- Applies to Creo Parametric 4.0 and 5.0
- <https://redmine.buw-soft.de/issues/10518>

## Why

- Component selections are not automatically skipped in above Creo versions

## Resolution

- Issue is fixed
- Commands are removed for suppressed features

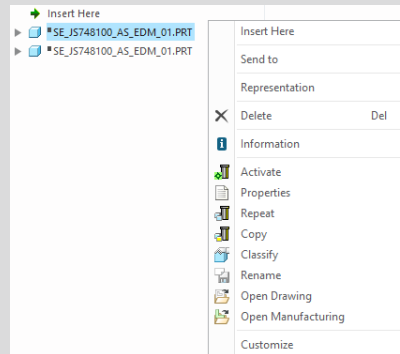

Before

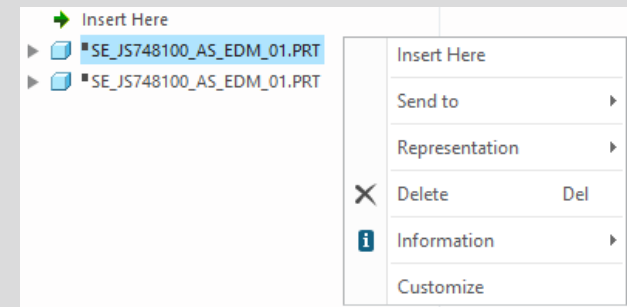

After

# Fixed Error

## What

- Crash in Base UI if no workpiece model found
- <https://redmine.buw-soft.de/issues/10488>

## Why

- It's not possible to read workpiece information if no component in assembly is marked as workpiece
- Parameter `SE_CORE_MODEL=1` not available

## Resolution

- Issue is fixed
- Always check if an active workpiece can be found and cancel functionality if necessary

# Fixed Error

## What

- Command 'New with Base' does not work anymore
- <https://redmine.buw-soft.de/issues/10407>

## Why

- SMARTElectrode checks selected template for completeness before its used
- This includes check for parameters
  - SE\_EDM\_SUPPLIER
  - SE\_EDM\_TYPE
- Command is canceled if any expected parameter is missing

## Resolution

- Issued is fixed
- SMARTElectrode extracts supplier and type from selected data file:  
configuration/electrode/<supplier>/<type>.dat

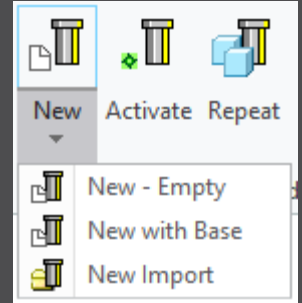



# Fixed Error

## What

- Help does not open if path contains spaces or special characters.

## Resolution

- Issue is fixed.



# SMARTElectrode 13.0.0.0

*What's New*

software  
**B&W**

# Multibody support

## What

- Support for new multibody features introduced in Creo Parametric 7.0 [<https://redmine.buw-soft.de/issues/9973>]

## Who needs it

- All customers working with Creo Parametric 7.0

## Details/Usage

SMARTElectrode supports multibody features in following modes/models/features:

- Assembly creation for all available methods (original model, merge, copy-geom, inheritance)
- Electrode design
  - Features creating a solid are automatically created in default body or body selected implicitly by references
  - Features without geometrical references like base or support are created in active or default body

## Impact/ Compatibility

- Additional features may be added with new releases from PTC

# Improvement

## What

- Added threshold to show a warning if contact area covers more than defined percentage of blank area  
[\[https://redmine.buw-soft.de/issues/10357\]](https://redmine.buw-soft.de/issues/10357)

## Who needs it

- Users who output effective contact area for EDM programming

## Details/Usage

- SE performs a fast contact area calculation when Base UI is opened and contact area is 0
- Slower more exact calculation can be started by user in UI
- Check UI always performs the exact calculation
- Option “CONTACT\_AREA\_MAX\_COVERAGE” defines valid percentage
- Warnings are shown in Base UI and Burnsheets notifications

CONTACT_AREA_MAX_COVERAGE	80	Maximum valid coverage of the blank area with contact areas in percent.
---------------------------	----	-------------------------------------------------------------------------

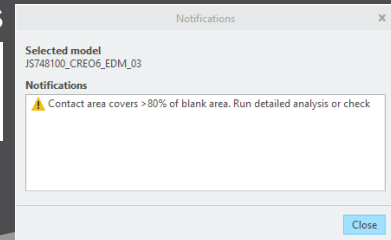
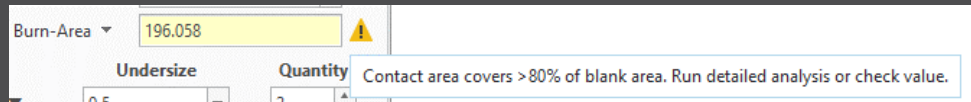

# Fixed error

## Description

- Edited base values are reset on next change  
[<https://redmine.buw-soft.de/issues/10218>]

A_BASE	17.500	▲▼	D1	5.128	▲▼
B_BASE	15.000	▲▼	D2	40.000	▲▼
LENGTH	48.000	▲▼	D3	0.022	▲▼

A_BASE	15.000	▲▼	D1	5.128	▲▼
B_BASE	15.000	▲▼	D2	35.000	▲▼
LENGTH	43.000	▲▼	D3	0.022	▲▼

## Cause

- Edited values are not correctly saved to template data

## Solution

- Problem is fixed

# Fixed error

## Description

- Some electrodes are not processed during output [<https://redmine.buw-soft.de/issues/10191>]

## Cause

- SE validates every electrode during export and skips suppressed, disabled or incomplete components.
- Check for completeness includes a check of electrode base group
- Check for completeness fails on imported or legacy electrodes as base is not created by UDF.

## Solution

- SE now looks for existence of mandatory EDM coordinate system
- Legacy electrode use “EDM\_ORIGIN” or “EDM\_ORIGIN\_TOP” depending on option value “USE\_POS\_CSYS\_TOP”
- Electrodes beginning with version 8.0 use csys name defined in option “EDM\_ORIGIN\_NAME”