



SMARTElectrode 14.1.3.0

What's New



Enhancement

What

- Add new commands to group 'View' to display workpieces or electrodes with transparency.

Why

- Simplifies visual inspection of electrode's touching faces.

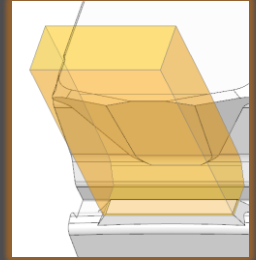

How

- Open menu to select style to activate.
- Only one style can be active at any time.
- Select option a 2nd time to disable style and return to default display.

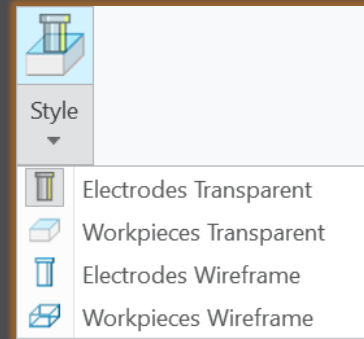

Fixed error

Description

- Erroneous creation of FREE_FACE in new electrodes (offset in negative direction).
- Erroneous adjustment of FREE_FACE in Base UI.
- <https://redmine.buw-soft.de/issues/16099>

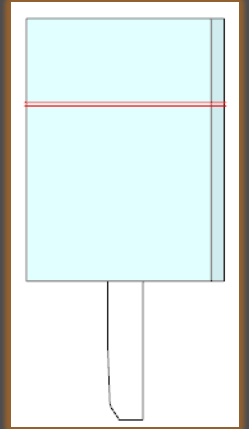
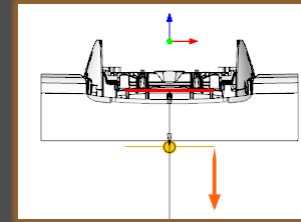

Cause

- Opposite orientation of start datums in electrode template.

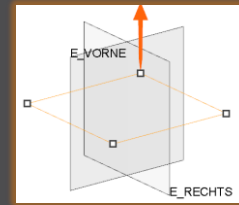
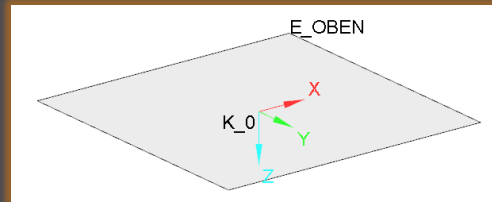

Solution

- Check orientation of 1st solid csys vs. reference of FREE_FACE.
- Process inverted orientation during definition and redefinition.

Fixed error

Description

- Consider flipped normal vector for user-defined FREE_FACE.
- <https://redmine.buw-soft.de/issues/16074>

Cause

- Normal vector of user-defined FREE_FACE created on reference surface is not automatically parallel to normal vector of reference surface.

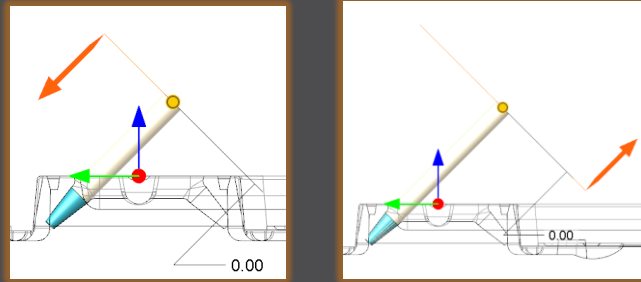

- This may lead to a wrong orientation of FREE_FACE and base features.

Solution

Check orientation of datum plane FREE_FACE after creation and flip normal vector if necessary.

Fixed error

Description

- Table 'asm_edm' on separate electrode part drawing empty.
- <https://redmine.buw-soft.de/issues/16088>

Cause

- Assembly model not added as drawing model to electrode part drawing.
- Therefore, the table remains empty.

Solution

Add missing drawing model automatically before repeat region (table) is updated.

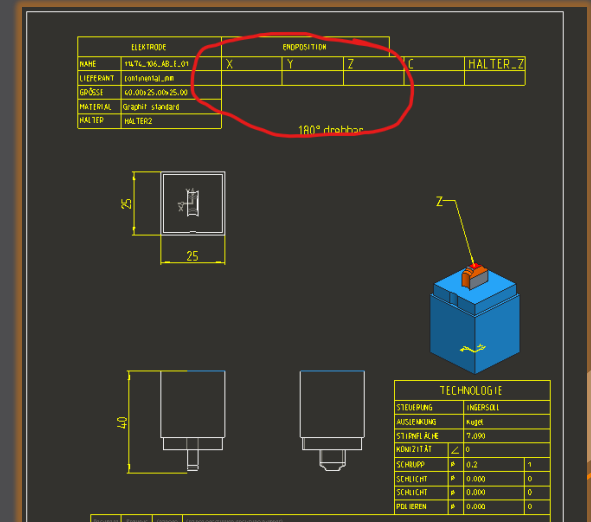

Fixed error

Description

- Automatic adjustment of Z position of FREE_FACE in Base UI fails.
- <https://redmine.buw-soft.de/issues/15938>

Cause

- Affected Versions:
SMARTElectrode 15.1.2.0 in Creo 9.0.0.0 and 9.0.1.0
- More Information:
<https://www.ptc.com/en/support/article/CS369850>.
- This issues leaves electrode base in initial position without any optimization.

Solution

Replaced broken API command with alternative solution.

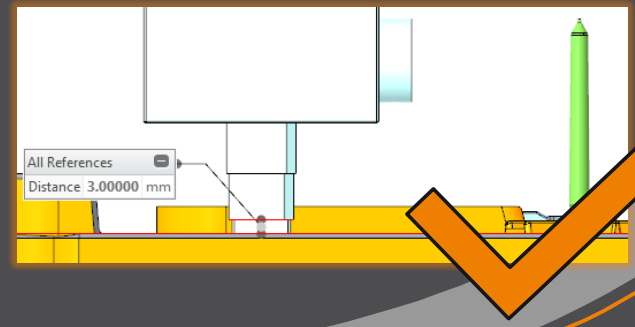
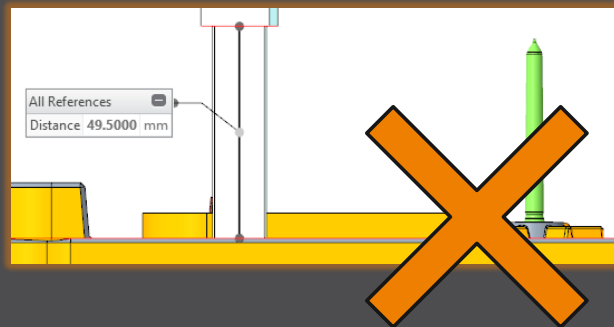

Fixed error

Description

- Export of electrodes associated to different zero point possible.
- <https://redmine.buw-soft.de/issues/15864>

Cause

- When exporting electrodes by selection or simplified representation, different zero points may be mixed.

Solution

- Selection of a zero point is now mandatory before export can be started.
- Electrodes not associated to selected zero point are skipped during export.
- A message is displayed if electrodes have been skipped.

Export by	
<input type="radio"/> Operation	JS748100_AS_EDM_08=149
<input type="radio"/> Simp.-Rep.	JS748100_AS_EDM_09=184
<input checked="" type="radio"/> Selected	JS748100_AS_EDM_03=71

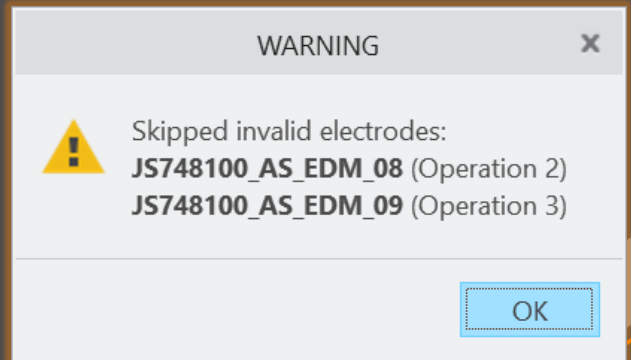



SMARTElectrode 14.1.2.0

What's New



Enhancement

What

- Add automatic interference check as options to ribbon.
- <https://redmine.buw-soft.de/issues/7330>
- <https://redmine.buw-soft.de/issues/7733>

Why

- Offer instant feedback on changes in assembly or active component mode.

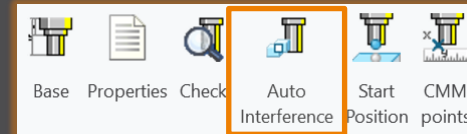
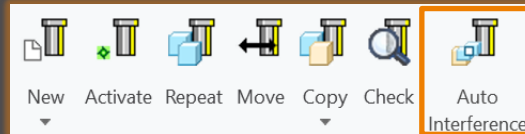

How

- Enable mode to start evaluation automatically on regenerate, feature creation/suppress/resume/delete.
- Activation in assembly mode also activates check in component mode.
- Activation in component mode only check active electrode and displays results for the same. Results from other components are hidden.
- Use option `AUTO_INTERFERENCE_CHECK` to preset behavior in assembly mode.
- Use option `AUTO_INTERFERENCE_COMP_CHECK` to preset behavior in active component mode.

Enhancement

What

- Ingersoll MultiProg/PowerSparkEditor: Introduce new parameter to write burn-depth.
- <https://redmine.buw-soft.de/issues/14573>

Why

- Manufacturing depth is useful for edm program creation.

How

- Add parameter with rule '&burndepth' to configuration.

```
BURN_DEPTH COMP DOUBLE Y N 8.3 N Y &burndepth
```

- It's recommended to add parameter as COMPONENT parameter to allow a different value for each electrode position.
- Value can be unlocked and overwritten.
- Default value will be calculated based on copied burn-faces (copy-geoms).

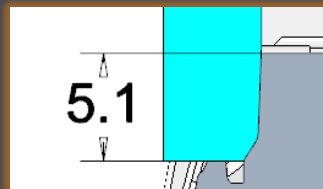
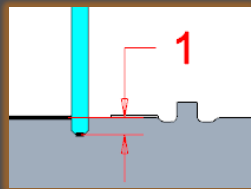

Enhancement

What

- New parameter owner 'PROJECT'.
- <https://redmine.buw-soft.de/issues/15169>

Why

- In some cases, its necessary to transfer a parameter value from assembly to electrode while maintaining the default rule for identification.
- Default rule '&inherit' not useable in these cases.

How

- Add parameter with owner 'PROJECT' in parameter configuration.
- Project parameters are automatically saved to assembly and electrode parts.
- Values can be unlocked and overwritten on assembly level or electrode part level.
- Value in assembly is the leading for locked part parameters.

```
PROJECTNR    PROJECT STRING N N 12 N Y &projectid  
ORDERNR     PROJECT STRING N N 12 N Y &order
```

Improvement

What

- Update simplified representations for enabled/disabled workpieces.
<https://redmine.buw-soft.de/issues/10294>

Why

- Disabled workpieces should be hidden on drawing.
- Disabled workpieces shouldn't affect workpiece outline/dimensions

How

- Open Burnsheat UI and use context menu to enable/disable workpieces.

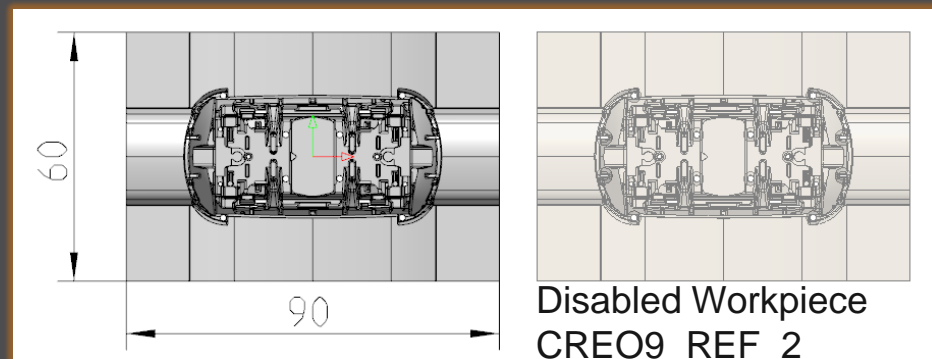
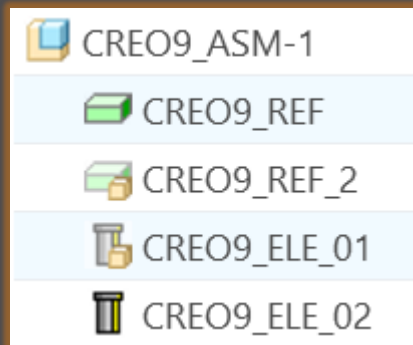

Improvement

What

- Unlink FREE_FACE from default plane in assembly.
<https://redmine.buw-soft.de/issues/15655>

Why

- FREE_FACE is currently an offset datum plane from operation's default plane.
- This leads to problems if the electrode is reused in a different assembly.
- FREE_FACE is frozen and can't be changed if original assembly is not in session.

How

- FREE_FACE is now an offset from a local datum plane removing the external reference.
- Modification also works in assemblies reusing the electrode.

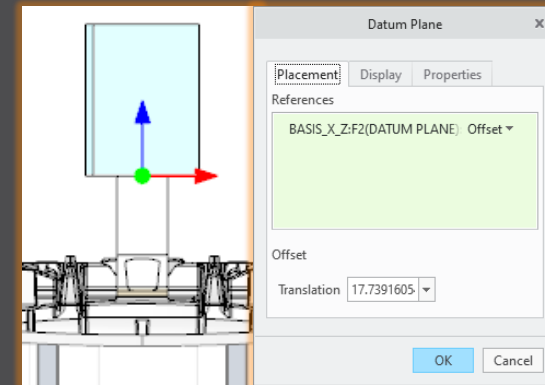
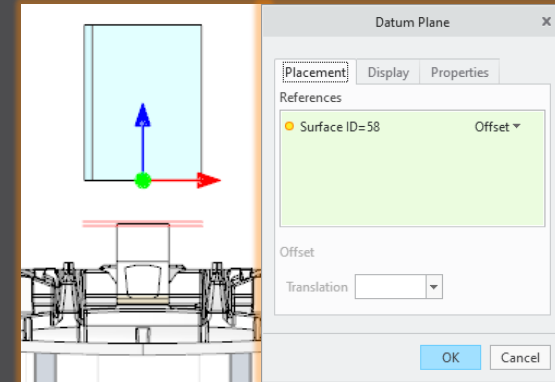

Improvement

What

- Allow usage of multiple placeholders for drawing tables on templates.
<https://redmine.buw-soft.de/issues/7306>

Why

- Requirement to display electrode information in different tables.
- For example, position and technology information should be displayed in separate tables:

X	Y	Z	C
-15,800	3,375	5,000	0,000
15,800	3,375	5,000	0,000
15,800	-3,375	5,000	180,000
-11,800	-3,375	5,000	180,000

▼	▼▼	ORBIT	DEPTH
0.5	0.4	Kugel	1,000
0.5	0.4	Kugel	1,000
0.5	0.4	Kugel	1,000
0.5	0.4	Kugel	1,000

How

- Add placeholder tables to template with at least two rows and one column.
- Cell 1/1: table name (without extension .tbl).
- Cell 2/1: YES/NO (YES: use display from parameter configuration column 4).
- Only one table should be updated by software (=YES); the other tables should be used as saved (=NO).

ASM_EDM
YES

ADDITIONAL_TABLE
NO

Improvement

What

- Allow usage of multiple placeholders for drawing tables on templates.
<https://redmine.buw-soft.de/issues/7306>

How

Additional information

Used simplified representation by drawing template:

- **asm_bom**: Master.
- **asm_edm**: simplified representation of electrode (groups all positions of electrode).
- **asm_operation**: all electrodes belonging to operation.
- **asm_wp**: simplified representation “SE_WORKPIECES”.
- **edm_default**: simplified representation of electrode (groups all positions of electrode).

Improvement

What

- Provide a custom template with free size in Base UI.
- <https://redmine.buw-soft.de/issues/7209>

Why

- Available template sizes are provided in a data file located in:
`<configuration>/electrode/<supplier>/<type>.dat`
- Until now the last size in list is selected and changed if no matching size is found
- The name of the last size is still shown in Burnsheat UI and in drawing tables.
- The new release automatically adds a size “Custom” to the list.

How

- This size is used if no matching size is found, rounding base size (red) and reusing all other settings (blue) from last entry.
- Add your own custom size by adding A_BASE = -1 and B_BASE = -1 as last entry to data file. This skips automatic “Custom”.

Blank

Type	RECTANGULAR_BASE		▼
Size	CUSTOM		▼
Locked	<input type="checkbox"/> Blank	<input type="checkbox"/> Free Dim	
A_BASE	91.000	D1	5.000
B_BASE	9.000	D2	20.000
Length	39.000	D3	0.631

INSTANCE	A_BASE	B_BASE	LENGTH	D1	D2	D3
...						
Sondergrösse	-1	-1	50	5	20	0

Improvement

Description

- Interface ZK Alphamoduli: allow usage of custom order number.
- <https://redmine.buw-soft.de/issues/14989>

Cause

- By default, selected operation is used as order in output.
- Order number can be purely commercial information, therefore the need to overwrite the value arises.

Solution

- Introduction of new parameter rule '&order'.
- Can be used to set a custom order number.
- Selected operation will be used if custom parameter is empty.

```
ORDERNR      PROJECT  STRING  N   N   12   N   Y   &order
```

Fixed error

Description

- Interface ZK Alphamoduli: wrong recognition of blank shape for measure program type (MeasProgType).
- <https://redmine.buw-soft.de/issues/14990>

Cause

- In some cases, SE fails to recognize the shape of electrode frame leading to a wrong measure program type.

```
<!-- <MeasProgType>type of frame 0: Unknown; 1: Circle; 2: Rectangle -->  
<MeasProgType>1</MeasProgType>
```

Solution

- Improve process to recognize correct shape.
- Use custom parameter for output.
 - Parameter default &measureprogtype.
 - Add values to sel_list.txt.
- Use either automatic recognition or value from parameter.

parameter.cfg

```
PROGTYPE PART STRING N N 6 N Y &measureprogtype
```

sel_list.txt

```
#MEASUREPROGTYPE  
2  
1  
0
```

Fixed error

Description

- Interface AC Form: possible wrong output of path from start to end position (PrepDepth).
- <https://redmine.buw-soft.de/issues/14918>

Cause

Problem appears if:

- electrode with more than one position.
- one or more electrode positions differ in start or end position.

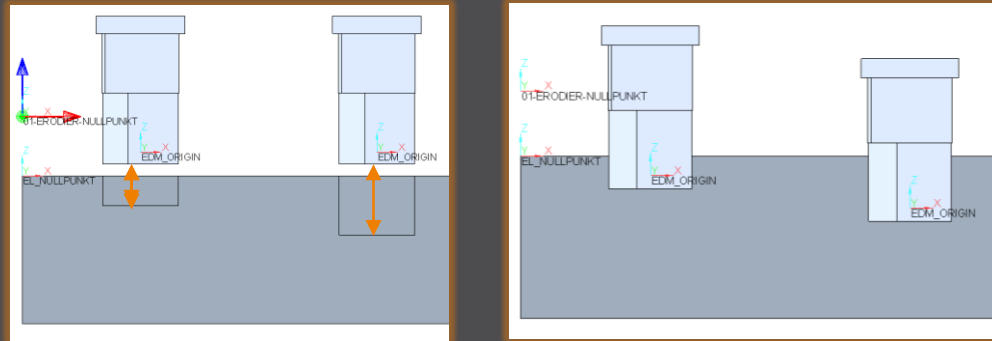

Solution

Each electrode position is exported as a new shape to avoid this problem.



SMARTElectrode 14.1.1.0

What's New



ENHANCEMENT

What

- Disable workpieces or electrodes in Burnsheat UI.
- <https://redmine.buw-soft.de/issues/4595>

Why

- Disable a design dummy. Especially when using electrode merge or mirror.
- Original position of an electrode should not be used in export.
- Use disabled auxiliary model to display a start-position.
- Disable outdated version of workpiece.

How

- Disabled components are ignored in export, collision check and touching surface analysis.
- Open Burnsheat UI and use right mouse button context menu to disable component.
- Disabled components are displayed with specific icons.

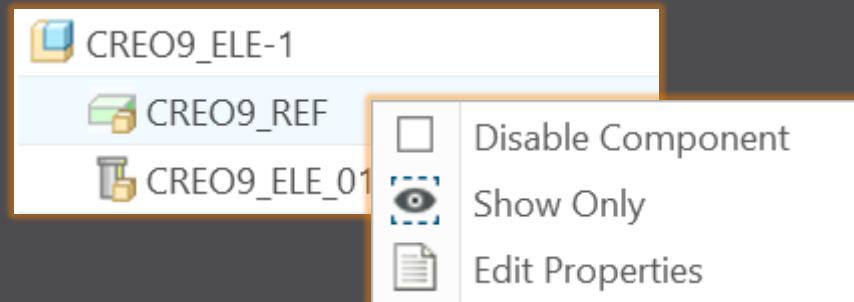

ENHANCEMENT

What

- Allow usage of layer settings file during export of 3d data.
- <https://redmine.buw-soft.de/issues/14469>

Why

- More control over the result of the export.

How

- The file has to be named “layer_settings.txt” and has to be located in export or post-processor configuration. Examples can be found in configurations that create 3d exports. Customize content and rename “example_layer_settings.txt” to “layer_settings.txt” to activate.

Model Name	Export Status	Display Status	Layer Name
SE_EXPORT_TEMP	Exclude Content	Blank	SE_EXPORT_TEMP

Improvement

What

- Provide export profiles for some processors with installation.
- <https://redmine.buw-soft.de/issues/14257>

Why

- Some interfaces include export of electrodes as STEP, IGES or PARASOLID.
- Export profile is necessary to include datum points used as CMM points.

How

Added profiles to:

- processor/ZK/pp/def_profile.dep_step
- processor/MAKINO/pp/def_profile.dep_para

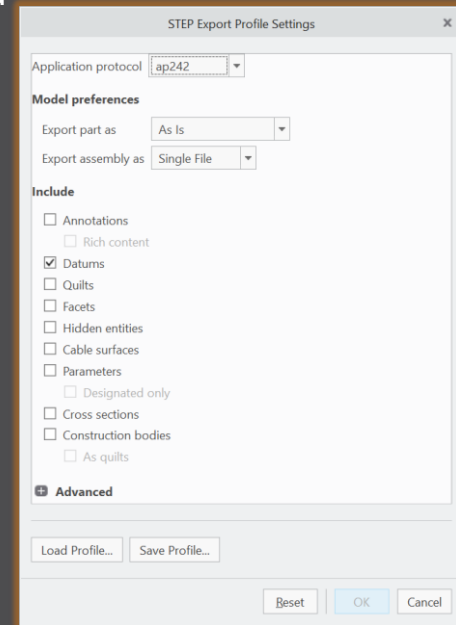

Improvement

What

- Automatically add all axes to layer “SE_EXPORT_TEMP” before 3d export file (IGES, STEP, ...) is created.
- <https://redmine.buw-soft.de/issues/14469>

Why

- Not needed datums like points, axes and planes are obstructive in downstream processes.

How

- Embedded axes in Extrude or Hole features are also considered.

Improvement

What

- Remove enforced regeneration of assembly to avoid continuous update of model data.
- <https://redmine.buw-soft.de/issues/14267>

Why

- SE automatically regenerates models with status “modified/outdated”. That is displayed by regeneration flag in status-bar.



- In some cases, Creo does not remove regen flag after successful regeneration.
- This leads to repeated regeneration of whole assembly if workpiece is affected.
- In such a case further processing is difficult, because of waiting times.

How

- Remove automatic regeneration.
- Users are now responsible to update design data when necessary.

Fixed error

Description

- Fix usage of wrong simplified representation in drawing repeat region after another drawing is merged.
- <https://redmine.buw-soft.de/issues/7504>

Cause

Problem appears if:

- user already created a drawing with repeat region
- adds a new electrode
- runs drawing creation again to add new sheet to drawing
- first repeat region may be changed to show data of merged drawing

Solution

SMARTElectrode automatically updates first occurrence of tables on drawing loaded from “asm_edm.tbl” and “asm_operation.tbl” after drawing creation.



SMARTElectrode 14.1.0.0

What's New



Fixed error

Description

- Allow renaming of manufacturing assembly and workpiece in Manufacturing UI and Rename UI.

- <https://redmine.buw-soft.de/issues/13988>

Cause

- A renamed electrode may not meet the naming format anymore
- Allow edit of default MFG and workpiece name in Manufacturing UI.
- Allow adjusting of names of existing MFG and workpiece during rename.

Solution

- Double click Mfg or Workpiece name in Manufacturing UI to edit names for objects to create (📄). Existing assemblies and parts (✅) can't be renamed Manufacturing UI.
- Rename UI shows input panels for MFG and workpiece if available.

ID	Electrode	Size	Status	Mfg Name	Workpiece Name	Template
1	SE_CREO8_EDM_01	15.0x15.0x28.0	✅	SE_CREO8_MFG_01	SE_CREO8_WP_01	mfg_default.asm
2	SE_CREO8_EDM_02	15.0x15.0x28.0	📄	SE_MFG_02	SE_CREO8_WP_02	

Rename

Electrode SE_CREO8_EDM_01

New Name SE_CREO8_EDM_01

Manufacturing SE_CREO8_MFG_01

Workpiece SE_CREO8_WP_01

OK Cancel

Improvement

What

- Prefer template without rotation ($C=0^\circ$) if several templates with same blank dimensions are available.

Why

- <https://redmine.buw-soft.de/issues/13672>
- Order of templates in .dat decided which template - with or without rotation - was assigned. This is improved by defined behavior.

How

Current Behavior

A	0.00
B	0.00
C	90.00

Z 5.0000

Blank
Type RECTANGULAR_BASE
Size 10X50

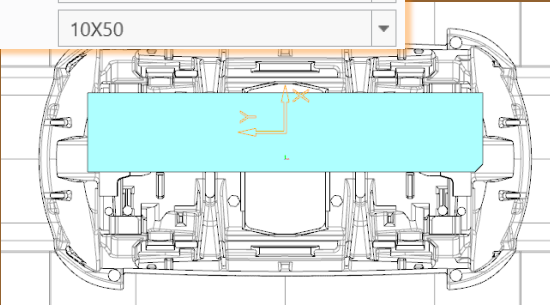

New Behavior

A	0.00
B	0.00
C	0.00

Z 5.0000

Blank
Type RECTANGULAR_BASE
Size 50X10

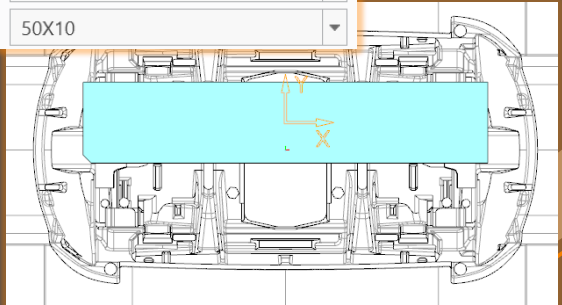

Fixed error

Description

- Ignore rotation of EDM_ORIGIN for default start and secure position
- <https://redmine.buw-soft.de/issues/13878>

Cause

- In some cases a rotated EDM_ORIGIN is useful
 - Easier definition of start position
 - EDM_ORIGIN is rotated for later NC setup
- In both cases either the calculated angles or the display are wrong

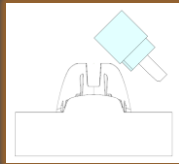

SX	SY	SZ	SA
0.000	18.887	1.571	-45.000

Solution

- Applied rotation to EDM_ORIGIN is ignored for calculation of angles.
- SE_EDM_BASE is used for electrodes created in current releases.
- EDM_ORIGIN is used for electrodes created in versions prior 8.0.

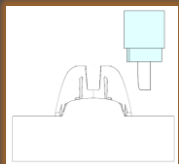

SX	SY	SZ	SA
0.000	18.887	1.571	0.000

Enhancement

What

- BREAKING CHANGE
- Consider contour height on calculation of default start- and secure-position.
<https://redmine.buw-soft.de/issues/13762>

Why

- Calculation of default start and secure position using EDM_ORIGIN led to disadvantageous or wrong values.
- Reduce effort to set start and secure positions.

How

- **NOTE:** Adjustment of operation default planes may be necessary to respond appropriately to the new behavior.
- New behavior is available for all assemblies from current versions.

Current Behavior

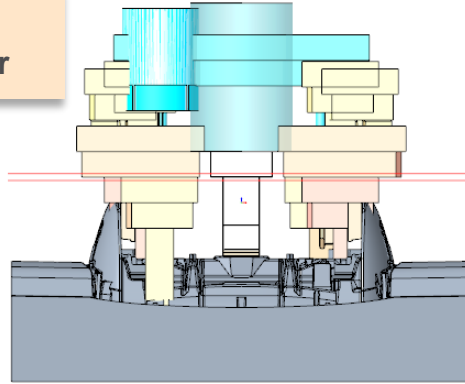

New Behavior

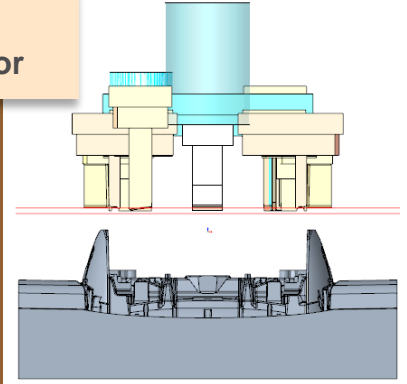

Enhancement

What

- Introduce new option #Electrode #LATERAL_KEEPOUT_DISTANCE
<https://redmine.buw-soft.de/issues/13766>

Why

- Defines the minimum distance in XY direction from the base that must not be disturbed by workpiece geometry.

How

- Default value '0'
- When adding a new base, position will be adjusted to...
 - ...meet normal distance D1 and
 - ...to fulfill lateral offset defined in LATERAL_KEEPOUT_DISTANCE

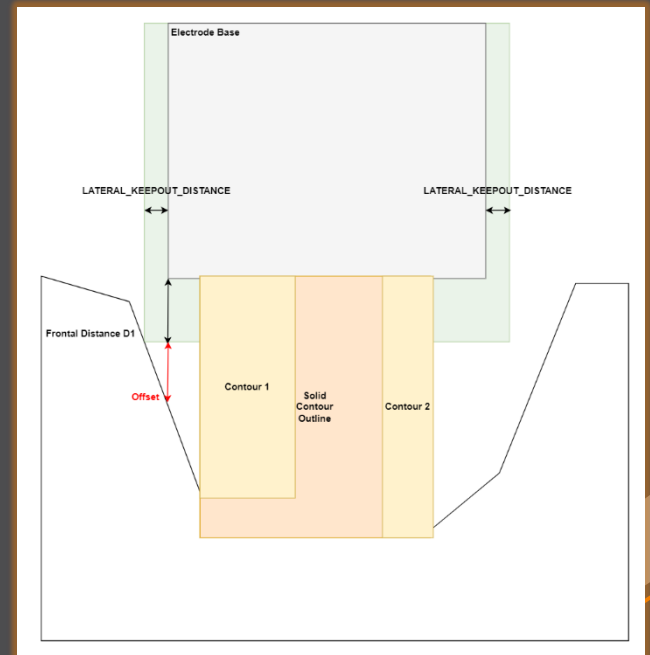

Enhancement

What

- Introduce new option #Electrode #SOLID_CONTOUR_CLEARANCE
<https://redmine.buw-soft.de/issues/13765>

Why

- Necessary to specify the minimum clearance in XY direction between the contour and blank outline

How

- Option value SOLID_CONTOUR_CLEARANCE defines the clearance added to electrode's solid contour before blank size selection.
- Default value '0'

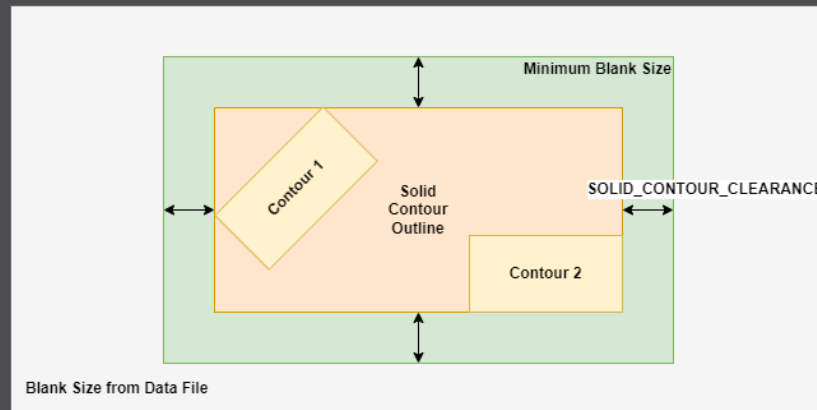

Improvement

What

- Allow enabling or disabling automatic calculation of a variable measure in the Base UI. <https://redmine.buw-soft.de/issues/13672>
- (related to: <https://redmine.buw-soft.de/issues/12517>)

Why

- Allows users to switch between both behaviors

How

1. **Variable dimension used (-1)**
Variable dimension will be disabled and calculated automatically based on other inputs.
2. **Blank unlocked**
Z position of blank length should stay fixed on input.
Change of D2 changes D2 and D3.
Change of Z position changes LENGTH and D3 accordingly.
Change of LENGTH changes LENGTH and D3 accordingly.
3. **Blank locked**
Blank (A_BASE, B_BASE, LENGTH and D2) are disabled and can't be changed. Changes to D1, D3 or Z position change the other two dependent values accordingly.

Blank

Type: RECTANGULAR_BASE_FRAME

Size: 15X15

Locked: Blank Free Dim

A_BASE: 15.000 D1: 5.128

B_BASE: 15.000 D2: 22.000

Length: 30.000 D3: 0.022

Chamfers: 1.000 0.200

Frame: 5.000 1.000

Blank

Type: RECTANGULAR_BASE_FRAME

Size: 15X15

Locked: Blank Free Dim

A_BASE: 15.000 D1: 5.128

B_BASE: 15.000 D2: 22.000

Length: 30.000 D3: 0.022

Chamfers: 1.000 0.200

Frame: 5.000 1.000

Blank

Type: RECTANGULAR_BASE_FRAME

Size: 15X15

Locked: Blank Free Dim

A_BASE: 15.000 D1: 5.128

B_BASE: 15.000 D2: 22.000

Length: 30.000 D3: 0.022

Chamfers: 1.000 0.200

Frame: 5.000 1.000

Enhancement

What

- Allow export of files for Creo View
<https://redmine.buw-soft.de/issues/13699>

Why

- Provide data for downstream processes

How

- Use keywords “SE_EDM_BACKUP_PVS” or “SE_EDM_BACKUP_PVZ” in export template to create a file structure for Creo View (PVS) or a zipped archive of the files (PVZ). PVS creates a *.pvs for the file structure and numerated *.ol files containing viewable geometry.
- Example: export PVS/PVZ of assembly

```
Assembly PVS: #SE_EDM_BACKUP_DIR#\#partname#. #SE_EDM_BACKUP_PVS#  
Assembly PVZ: #SE_EDM_BACKUP_DIR#\#partname#. #SE_EDM_BACKUP_PVZ#
```

- Example: export PVS/PVZ for each electrode

```
ELECTRODE_START  
PVS: #SE_EDM_BACKUP_DIR#\#partname#. #SE_EDM_BACKUP_PVS#  
PVZ: #SE_EDM_BACKUP_DIR#\#partname#. #SE_EDM_BACKUP_PVZ#  
ELECTRODE_END
```

Enhancement

What

- Use default profiles or option files for 3D exports
<https://redmine.buw-soft.de/issues/13681>

Why

- Support of custom option files

How

- Save options file named “def_profile” to export/<type> or processor/<type>.

Type	Keyword in export template	Options file name
VDA	SE_EDM_BACKUP_VDA	def_profile.dep_vda
STEP	SE_EDM_BACKUP_STEP	def_profile.dep_step
IGES	SE_EDM_BACKUP_IGES	def_profile.dep_iges
CATIA	SE_EDM_BACKUP_CATIA	def_profile.dep_catv5
SAT (Acis)	SE_EDM_BACKUP_SAT	def_profile.dep_acis
NEUTRAL	SE_EDM_BACKUP_NEUTRAL	def_profile.dep_neu
X_T (Parasolid)	SE_EDM_BACKUP_X_T	def_profile.dep_para
UG (NX)	SE_EDM_BACKUP_UG	def_profile.dep_nx
JT (license necessary)	SE_EDM_BACKUP_JT	def_profile.dep_jt