



SMARTElectrode 12.0.8.0

What's New



Enhancement

What

- Edit properties of multiple objects in user interface
- <https://redmine.buw-soft.de/issues/12842>



Eigenschaften

Why

- Helpful if especially technology settings have to be updated

How

- Access Properties UI with several selected objects from modeltree or Burnsheat UI.
- Only parameters available in all objects are are.
- Parameters with different values will be displayed as **<Status quo>**.
- Edited values will be updated for all selected objects.
- Make sure to select all relevant objects before editing.

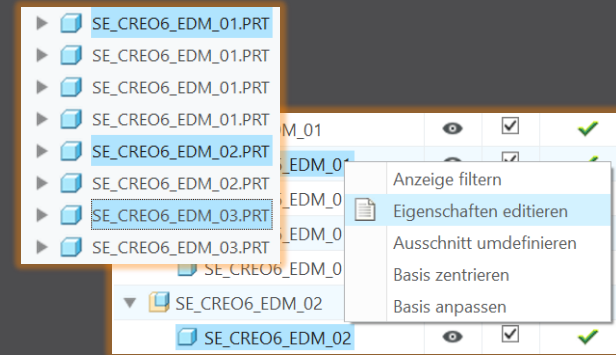

	PRIORITAET	<Status quo>	Very low wear
	BRENNFLAECH	<Status quo>	<Status quo>
	ANZAHL	3	3
	▼	<Status quo>	0.5
	ANZ_UNTERMAS	2	-

Enhancement

What

- Overhauled Options UI
- <https://redmine.buw-soft.de/issues/12059>

Why

- Appearance adjusted to PTC options look & feel

How

- Only changed values are saved
- Option file includes option value descriptions
- Easier discard and reset to defaults

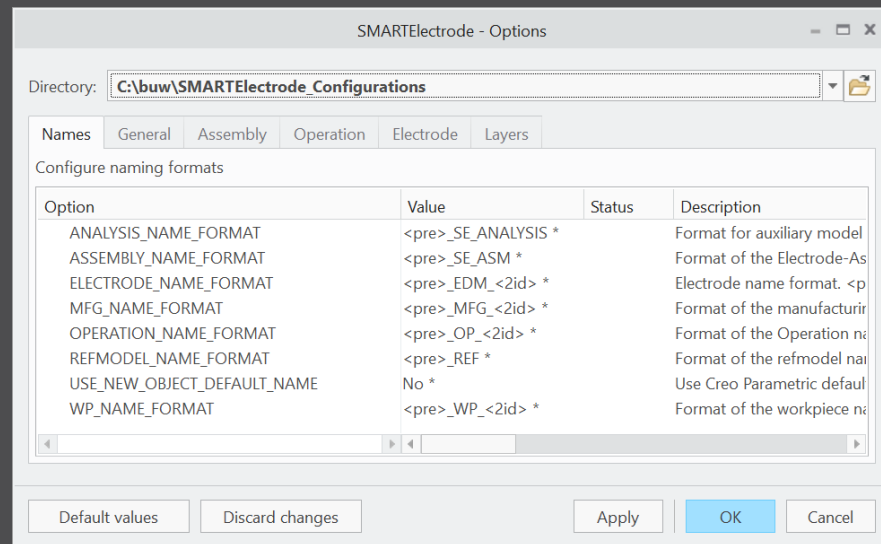

Improvement

What

- Base UI - allow overwriting of calculated values.
- <https://redmine.buw-soft.de/issues/12517>

Why

- Until now base dimensions calculated by SMARTElectrode have been disabled
- In some cases, users still need access to values after SMARTElectrode initially calculated them

How

All base dimensions are now accessible after SE placed the base group

1. Blank unlocked

Keep absolute Z position of blank length. Change of D2 changes LENGTH accordingly to keep position. Change of Z position changes LENGTH accordingly to keep position. Change of LENGTH changes D3 (top offset) accordingly.

2. Blank locked

Blank (A_BASE, B_BASE, LENGTH and D2) are disabled and can't be changed. Changes to D1, D3 or Z position change the other two dependent values accordingly

Blank

LOCKED 

TYPE: RECTANGULAR_BASE

SIZE: D2_VARIABEL

A_BASE	15.000	D1	5.150
B_BASE	15.000	D2	42.000
LENGTH	50.000	D3	0.000

Blank

LOCKED 

TYPE: RECTANGULAR_BASE

SIZE: LAENGE_VARIABEL

A_BASE	15.000	D1	5.150
B_BASE	15.000	D2	20.000
LENGTH	28.000	D3	0.000

Enhancement

What

- Edit CMM points in user interface
- <https://redmine.buw-soft.de/issues/12392>

Why

- Move measuring points to even value

How

- Open “CMM points”
- Select point to edit in table
- Start edit on double-click or press “Edit”
- Point will be automatically moved to new position or reachable coordinates are suggested if point is out of bounds
- Original coordinates are restored on cancel

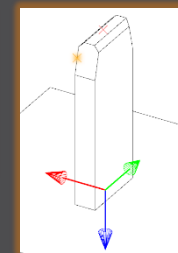
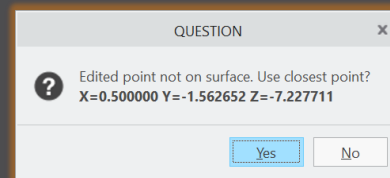
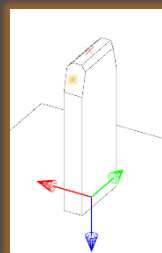
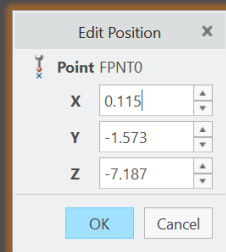

Enhancement

What

- Allow CMM points in workpiece models
- <https://redmine.buw-soft.de/issues/12327>

Why

- Enable definition and output of measuring points for CMM in workpieces

How

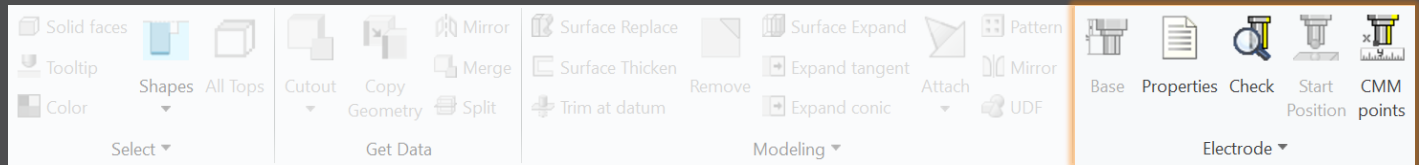

Workflow and functionality is the same as for electrodes

- Activate component
- Open “CMM points”
- “Add” measuring points on pick position till loop is cancelled with MMB
- Confirm or discard points

The 'Measuring Points' dialog box displays a table with columns ID, X, Y, Z, I, J, and K. The table contains three rows of data.

ID	X	Y	Z	I	J	K
1	26.17	3.98	2.57	0.81	0.26	0.95
2	29.11	2.26	83.16	0.97	0.09	0.24
3	26.32	2.11	5.24	0.80	1.00	0.05

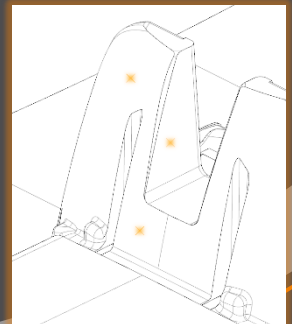

Improvement

What

- Measuring points can be added to template.
- <https://redmine.buw-soft.de/issues/11335>

Why

- For easier measuring of preset

How

- Each point feature has to carry a parameter "SE_QMM_POINTS" for identification.
- Use field points or general datum points.
- General datum point features may include multiple points.
- General datum points can't be edited in UI and are highlighted with a yellow background.
- **Note:** deletion of point in UI always deletes the whole feature.
- Use command "Save custom base" to update templates.

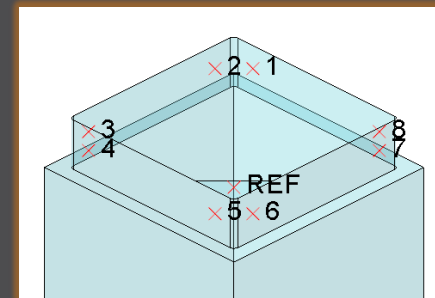

Name	Type	Value
SE_QMM_POINTS	Integer	1

Measuring Points

+ Add Edit X Delete Save

ID	X	Y	Z	I	J	K
1	5.00	6.50	1.50	-0.00	1.00	-0.00
2	6.50	5.00	1.50	1.00	0.00	0.00
3	6.50	-5.00	1.50	1.00	0.00	0.00
4	5.00	6.50	1.50	0.00	1.00	0.00

Improvement

What

- Export additional information for quality measuring to Z&K Alphamoduli.
- <https://redmine.buw-soft.de/issues/12839>

Why

- Enables an easier setup of CMM.

How

Name	Type	Description	Parameter Rule
TolMin	Float	Allowed lower tolerance for quality measuring	&qm_tol_min
TolMax	Float	Allowed upper tolerance for quality measuring	&qm_tol_max
PresetStylus	Char(32)	Stylus name for preset	&qm_preset_stylus
PresetTip	Char(32)	Tip name for preset	&qm_preset_tip
PresetPrehitDistance	Float	Prehit distance during preset	&qm_preset_prehit
PresetRetractDistance	Float	Retract distance during preset	&qm_preset_retract
QMStylus	Char(32)	Stylus name for measuring	&qm_stylus
QMTip	Char(32)	Tip name for measuring	&qm_tip
QMPrehitDistance	Float	Prehit distance during measuring	&qm_prehit
QMRetractDistance	Float	Retract distance during measuring	&qm_retract

Improvement

What

- Introduced workpiece naming format for Z&K Alphamoduli.
- <https://redmine.buw-soft.de/issues/12324>

Why

- Valid Creo name length of 31 characters may not available depending on EDM setup.
- Allow generation of short workpiece names.

How

- Use option SE_CORE_NAME_FORMAT to define a format for short names.
- CAD model name is used if options is undefined or empty.
- Any workpiece parameter from configuration can be used in format.
- Example setting in export.cfg:

```
! naming format for workpiece models in XML file  
SE_CORE_NAME_FORMAT WP_<ID>
```

- Result in XML:

```
<LogWrk>  
  <Name>WP_1</Name>  
  <CadModel>.\WORKPIECE\JS748100_AS.STP</CadModel>  
  <Remark>JS748100_AS</Remark>  
</LogWrk>
```

Improvement

What

- Automatic creation of dimensions on manufacturing drawing.
- <https://redmine.buw-soft.de/issues/12475>

Why

- Create a more complete NC drawing.

How

- Automatically add dimensions on NC drawing sheet similar how it works for electrode part drawings.
- Dimensions are created when drawing is copied from template.
- Edit configuration file `my_drawing_format.cfg` to add dimensions in list.
- Use MFG template name in 1st column.
- Refer to <https://www.buw-soft.de/en/news/add-workiece-dimensions-automatically/> for more information.

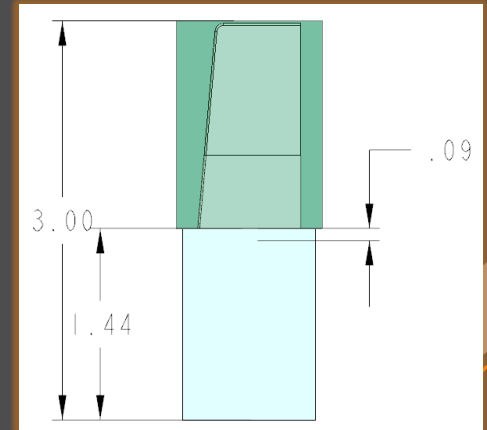
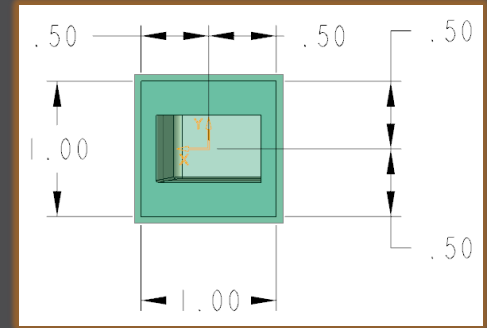

Improvement

What

- Drawing UI: new option to add positioning sheet to NC drawing sheet.
<https://redmine.buw-soft.de/issues/11270>

Why

- Add electrode position sheet to existing NC drawing sheet similar how it works for electrode part drawings.

How

- Info: NC drawing sheet can be part of manufacturing template which is assigned in Manufacturing UI and copied during creation of new manufacturing assembly.
- Set option
`MERGE_EDM_POSITION_SHEETS = 5`
to enable this behavior.

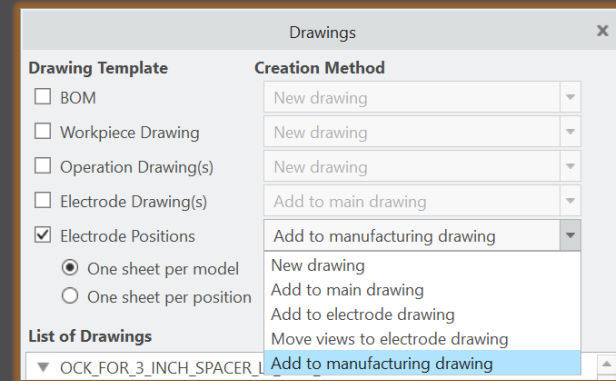

Fixed error

Description

- Different behavior for interference check in Creo 4 vs. 6, 7, 8 in active component mode.

- <https://redmine.buw-soft.de/issues/12837>

Cause

- Current releases of Creo Parametric 6, 7 and 8 **don't** support computation of interferences in active component mode.
- Behavior should be fixed in Creo 7.0.8.0, Creo 8.0.4.0 and Creo 9.0.0.0.
- Error won't be fixed in Creo 6.0.

Solution

- Interference check will be disabled in active component mode in affected Creo Parametric versions till fix is available.

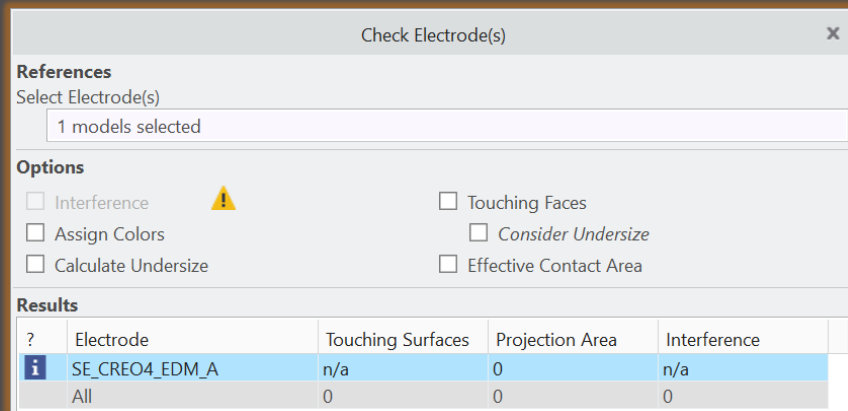

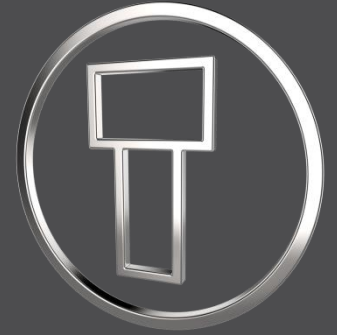

SMARTElectrode 12.0.7.0

What's New



Enhancement

What

- Added new command to “Save Custom Base” to save userdefined feature (UDF) and data file for electrode blank.
- <https://redmine.buw-soft.de/issues/12001>

Why

- New command simplifies creation of customized base and saves a valid data file for it.

How

- Use command "Open Configuration" to browse to "electrode*<supplier>*\base_templates“ and select part to customize.
- Incorporate changes.
- Select "Save Base Template" to create UDF and data file.
- Customize data file.
- Copy UDF and DAT to supplier directory to activate template
- **NOTE:** All variable dimensions to be controlled in data file require a custom symbol name.
- **NOTE:** Open “Getting-Started” document for more information.

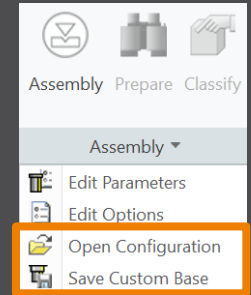

Enhancement

What

- Allow additional variable dimensions and parameters in blank data file (*.dat)
- <https://redmine.buw-soft.de/issues/9953>

Why

- Customer specific templates sometimes need to control additional dimensions or parameters – for example if holder or order number are part of electrode blank

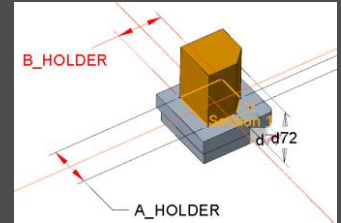

How

- To use additional parameters with data file an additional line “VALUETYPE” has to be added between “INSTANCE” and blank sizes.

INSTANCE	A_BASE	B_BASE	FRAME_WIDTH	FRAME_HEIGHT	A_HOLDER	B_HOLDER	PARAMINT	PARAMSTRING	PARAMDOUBLE
VALUETYPE	DIM	DIM	DIM	DIM	DIM	DIM	INTEGER	STRING	DOUBLE
E-15-15	15	15	1	3.2	15	15	1515	E-15-15	15.15

- Available types:
 - DIM → Creo dimensions like A_BASE, B_BASE, LENGTH, base height D2 and additional dimensions
 - INTERN → internal values used for calculation and advanced settings like D1, D3, MATERIAL, MFG_TEMPLATE, HOLDER, ...
 - INTEGER → integer parameter
 - STRING → string parameter
 - DOUBLE → double parameter
- **NOTE:** more information can be found in “Getting-Started” presentation

Improvement

What

- Adjusted behavior for default values from parameter configuration.
- <https://redmine.buw-soft.de/issues/12025>

Why

- Until now there have been two different behaviors for default values if...
 - defined in sel_list.txt or

```
SPARK_MODE ... &priority
```

```
#PRIORITY  
Normal wear  
Low wear  
Normal wear  
High removal
```

- defined in parameter.cfg directly

```
SPARK_MODE ... Normal wear
```

How

Now in both cases...

- default value defined in parameter.cfg and
- default value defined in sel_list.txt

...the value from SMARTElectrode configuration will be used now. The value will be set regardless whether the parameter already exists in template for new electrodes or not.

Improvement

What

- Check and update mandatory options before drawings are created.

Why

- Drawing creation may fail if following options can't be set temporarily by SMARTElectrode
 - start_model_dir
 - drawing_view_origin_csys
 - drawing_warn_if_flex_feature
 - save_display

How

A warning will be displayed.

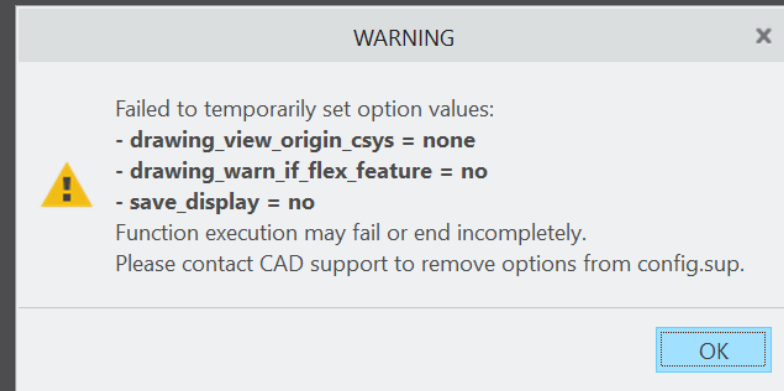

Fixed error

Description

- Operations/origins unreadable if group changed.
- <https://redmine.buw-soft.de/issues/12010>

Cause

- SMARTElectrode expects a fixed sequence order in operation groups:
 - Reference Csys (this is the selected csys)
 - Default Csys (orientation like selected csys on assembly default; used to assemble new electrodes on)
 - Freeface datum plane (default position of electrode base)
 - Default start datum plane (default start position of electrode if not defined otherwise)
 - Default secure datum plane (default secure position of electrode if not defined otherwise)
 - Operation cosmetic for drawing (optional)

Solution

- SMARTElectrode tries now to identify features in group, but it's still recommended to keep the group unchanged.

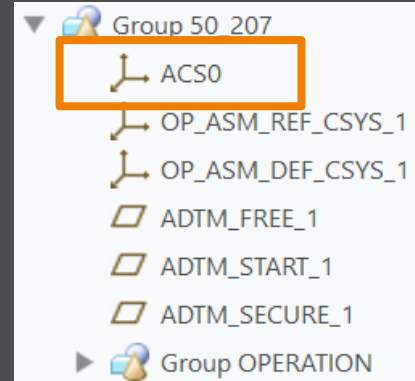

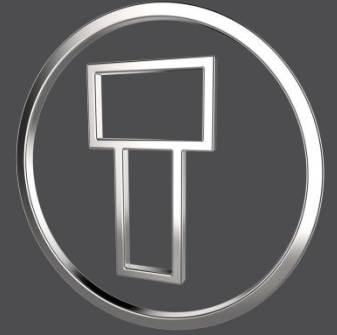

SMARTElectrode 12.0.6.0

What's New



Enhancement

What

- Allow surface models as workpieces
- <https://redmine.buw-soft.de/issues/11584>

Why

- Workpieces are sometimes only available as surface models and can't be repaired via Import Data Doctor (IDD)

How

- Use method "original models" to create assembly from surface models
- SMARTElectrode offers support for:
 - Workpiece: outline calculation of workpieces
 - Operation: offset calculation in operation definition
 - Design: cutout creates a solid and a solidify feature if referenced workpiece is a surface model. Solidify may fail if quilt includes gaps.
 - Analysis: touching surface analysis for effective contact area
- **NOTE** computation of interference is unavailable for surface models. A warning will be displayed in Check UI

Interference

⚠ Workpiece TUTORIAL3_OFFEN is surface model. No calculation possible!

⚠ Workpiece TUTORIAL3_OFFEN is surface model. No calculation possible!

Enhancement

What

- Introduced layer definition in my_drawing_format.cfg to control display status
- <https://redmine.buw-soft.de/issues/10575>

Why

- It's a tedious task to set correct layer display on electrode drawings

How

- Add section enclosed with .BEGIN_LAYERS and .END_LAYERS to my_drawing_format.cfg
- Define drawing template name, view, layer and display status in a tab separated table
- Drawing name from configuration\templates: asm_bom, asm_wp, asm_operation, asm_edm, edm_default
- View to assign layer setting to. Use VIEW name to set display of layer in a specific view. Use TOP_MODEL to set display of layer on drawing sheet.
- Layer name whose display status is to be set
- Display status: Set YES to show layer; Set NO to hide layer

Enhancement

What

- Electrode base can now also be added on a user-defined coordinate system
- <https://redmine.buw-soft.de/issues/8704>

Why

- To lock the position of the base on an axis
- To prepare a geometry pattern of the contour

How

- Define coordinate system in electrode
- Select coordinate system and open Base UI
 - Base will be added to coordinate system
 - Position of coordinate system is taken into account to calculate required blank size
- Base is locked to coordinate system. Delete base to use different option

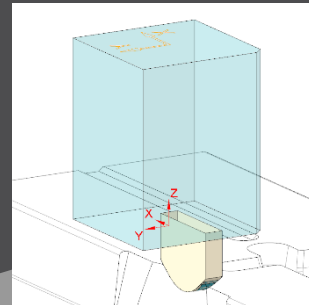
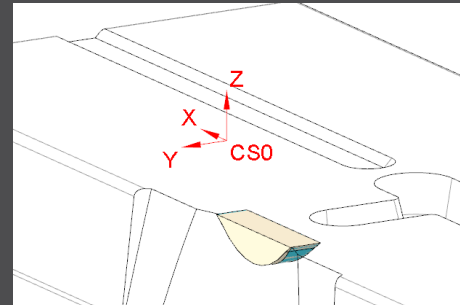
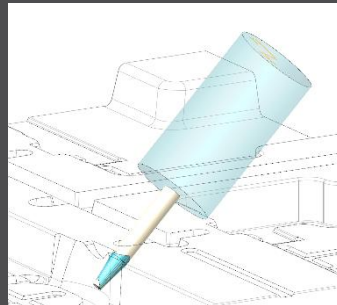
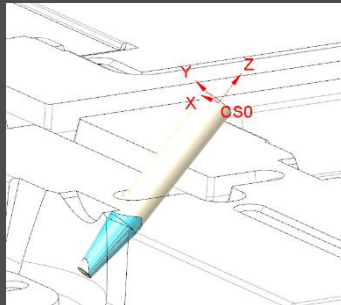

Enhancement

What

- Copy electrodes from existing electrodes or prepared templates
- <https://redmine.buw-soft.de/issues/11700>

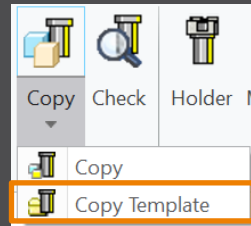

Why

- Allow reuse of...
 - incomplete electrode models to be completed inside assembly (for gate electrodes)
 - complete electrode models created without SMARTElectrode (for electrodes from stock)
 - complete electrode created with SMARTElectrode (for electrodes from different assembly)

How

- Csys defined in option SE_EDM_ORGIN_NAME is mandatory
- "configuration\electrode\templates" is used as default path to select templates
- Associated data (drawing, manufacturing) will be copied to new name also
- Controls in Base UI will be disabled if template is detected

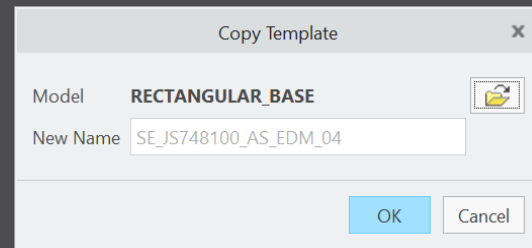

Improvement

What

- Electrode design mode:
Maintain definition of surface collections when creating copy-geoms
- <https://redmine.buw-soft.de/issues/11765>

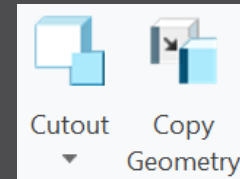

Why

- So far, a new copy-geom was created for each surface set on >Get Data >Cutout and >Get Data >Copy Geometry

How

- Surface sets in selection buffer are now automatically sorted by reference model
- All surface sets from same reference model will be added to same copy-geom feature



Surface Sets		
Set	Count	
Individual Surfaces	0	Add
Seed and Boundary Surfaces	9	Remove
Seed and Boundary Surfaces	9	
Excluded Surfaces	0	

Improvement

What

- Base UI - keep predefined holder offset if different holder is selected on details page
- <https://redmine.buw-soft.de/issues/10943>

Why



- Adapts behavior of Base UI to Holder UI. Offset / rotation will be retained if a different holder is selected

How

- Selection of new blank type or size updates holder and position

	25X85X60_025MM
B_BASE	25X85X60_100MM
	35X35X60
LENGTH	35X35X60_025MM_1
CHAMFER	35X35X60_025MM_2

- Current position will be retained if a new model is selected on details page

Holder	
Supplier	EROWA
Type	F60000
	 Edit Position
	 Reset Position

- A new popup menu allows edit and reset of holder position

Interface to Ingersoll MultiProg

What

- Suppress output of generator types to ING file
- <https://redmine.buw-soft.de/issues/10943>

Why

- Set undersize values are mapped on generator types in output
- Some customers prefer output without generator types

	Undersize	Quantity
▼	0.5	2
▼▼	0.4	1
▼▼▼	0.30	1
▼▼▼▼	0.20	1

How

- Add option WRITE_GENTYPEL NO to export.cfg to suppress output
`WRITE_GENTYPEL · NO`
- File is located in configuration\processor\INGERSOLL\pp\export.cfg
- Generator types based on undersize values
 - RO: roughing
 - PF: prefinish
 - FI: finish
 - FF: fine finish

Interface to ZK Alphamoduli

What

- Calculate <SafetyDistance> based on electrode contour height and position of MEASZPOINT

- <https://redmine.buw-soft.de/issues/11881>

Why

- <SafetyDistance> uses a fixed value from export.cfg currently
- A calculation based on contour height is necessary

How

- Two options in export.cfg control behavior for <SafetyDistance>
 - SafetyDistance ... → fixed to be considered at the CMM.
 - SafetyDistanceOffset ... → offset for safety distance added to measured distance from blank length to MeasZPoint

- **Note**
Only use SafetyDistance or SafetyDistanceOffset!

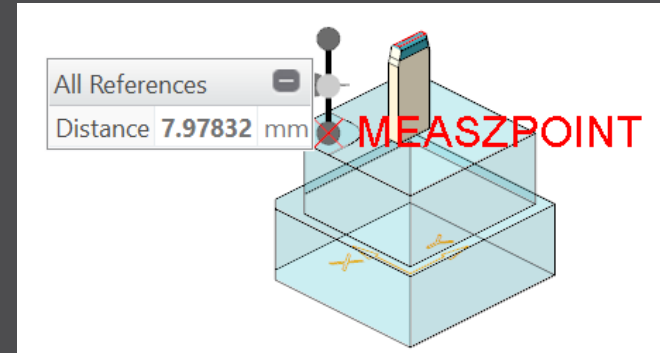

Interface to ZK Alphamoduli

What

- Allow alternative csys for output of measure information
- <https://redmine.buw-soft.de/issues/11585>

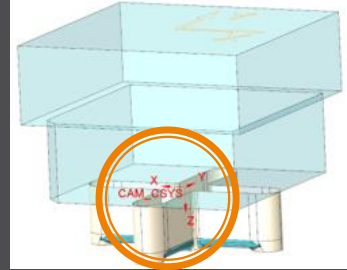
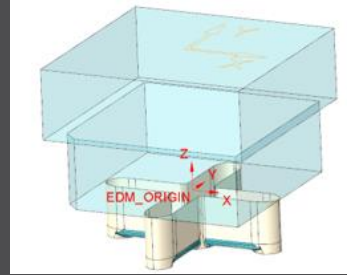

Why

- All measuring information like

```
<MeasSizeX>38.0000</MeasSizeX>
<MeasSizeY>38.0000</MeasSizeY>
<MeasSizeZ>0.0000</MeasSizeZ>
<MeasZPointX>-16.5000</MeasZPointX>
<MeasZPointY>-16.5000</MeasZPointY>
<MeasZPointZ>0.0000</MeasZPointZ>
<QMPoint>
...
</QMPoint>
```

- ... need to be output for csys with correct orientation
- Use setting “SE_EDM_BACKUP_CSYS” in export.cfg to set csys names
- Several alternative csys can separated by ;
- Option names will automatically be replaced by value

How

```
SE_EDM_BACKUP_CSYS · EL_CSYS; · CSYS_DEFAULT; · ANY_CSYS;
SE_EDM_BACKUP_CSYS · CAM_CSYS_NAME; · EDM_ORIGIN_NAME;
```

Interface to ZK Alphamoduli

What

- Add <MeasureProg> to XML output
- <https://redmine.buw-soft.de/issues/11659>

Why

- MeasureProg is the name of the learning/measuring program for the automatic presetting at the CMM

How

- A measure frame needs to be available to output <MeasureProg>
- Default values are:

```
<!-- default for rectangular frame: ESVierkant -->  
<MeasureProg>ESVierkant </MeasureProg>  
<!-- default for round frame: ESMitteKreis -->  
<MeasureProg>ESMitteKreis</MeasureProg>
```

- Custom names for <MeasureProg> can be defined in parameters
 - Parameter configuration
MEASUREPROG PART STRING N N 10 N Y &measureprog
 - Selection list in sel_list.txt
#MEASUREPROG
...

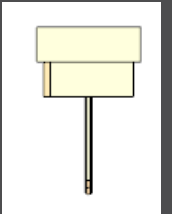
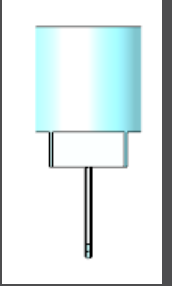

Interface to ZK Alphamoduli

What

- Suppress `<MeasProgType>` and `<MeasSize...>` if no frame available
- <https://redmine.buw-soft.de/issues/11537>
- <https://redmine.buw-soft.de/issues/11587>

Why

- `<MeasProgType>` and `<MeasSize...>` are only valid if a measuring frame is available in blank
- Output is suppressed if frame is not found

```
<MeasProgType></MeasProgType> > empty  
<MeasSizeX></MeasSizeX> > skipped  
<MeasSizeY></MeasSizeY> > skipped  
<MeasSizeZ></MeasSizeZ> > skipped
```

- Example electrodes without frames:

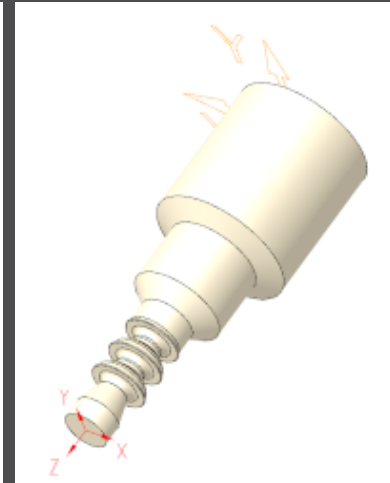
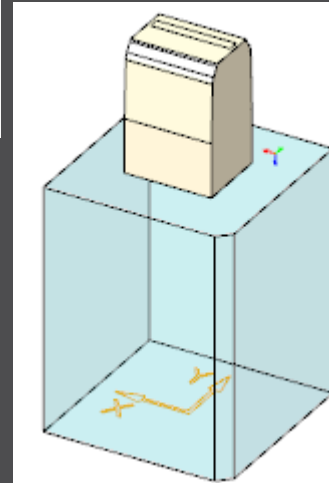

Interface to ZK Alphamoduli

What

- Allow custom name for MeasZPoint in export settings
- <https://redmine.buw-soft.de/issues/11586>

Why

- MeasZPoint is the datum point where Z-height should be measured
- Datum point may be available in customer templates with different name

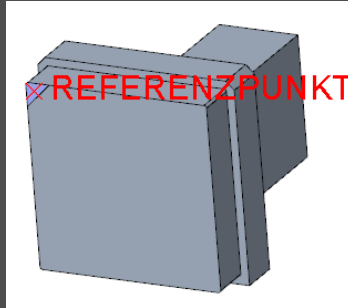

How

- Add option MeasZPoint <name> to export.cfg
 - An existing datum point named “MEASZPOINT” will be renamed on export
- ```
! · name · of · datum · point · feature · to · use · for · MeasZPoint
MeasZPoint · MEASZREF
```
- **NOTE** Datum point needs to be reachable!

# Interface to ZK Alphamoduli

## What

- Name format options to shorten names in XML output
- <https://redmine.buw-soft.de/issues/11855>

## Why

- Depending on EDM machine setup length of 32 characters may **not** be available for electrode names in XML
- Creation of shorter names is required

## How

- Naming options SE\_EDM\_NAME\_FORMAT and SE\_2<sup>ND</sup>\_EDM\_NAME\_FORMAT introduced. Examples:
  - SE\_EDM\_NAME\_FORMAT EDM\_<ID>
  - SE\_2<sup>ND</sup>\_EDM\_NAME\_FORMAT <partname><any known parameter>

```
<LogEle LogGroup=„SE_EDM_NAME_FORMAT“>
 <Name>SE_EDM_NAME_FORMAT</Name>
 <Remark>SE_2ND_EDM_NAME_FORMAT</Remark>
 <DocList>
 <Document>
 <Name>SE_2ND_EDM_NAME_FORMAT</Name>
 <File>SE_2ND_EDM_NAME_FORMAT</File>
 </Document>
 </DocList>
</CadModel>SE_2ND_EDM_NAME_FORMAT</CadModel>
```



# Fixed Error

## What

- Assignment of combined states to drawing views fails sometimes
- <https://redmine.buw-soft.de/issues/10772>

## Resolution

- Replaced combined states with a list of layer definitions which can be controlled independently from 3d model
- Details [here](#)

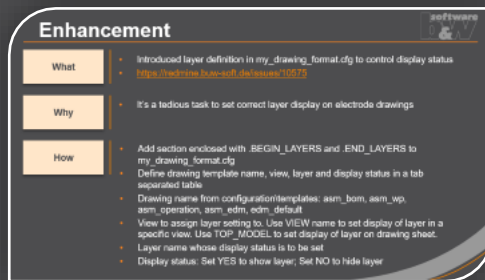

**Enhancement**

**What**

- Introduced layer definition in `my_drawing_format.dwg` to control display status
- <https://redmine.buw-soft.de/issues/10772>

**Why**

- It's a tedious task to set correct layer display on electrode drawings

**How**

- Add section enclosed with `BEGIN_LAYERS` and `END_LAYERS` to `my_drawing_format.dwg`
- Define drawing template name, view, layer and display status in a tab separated table
- Drawing name from configuration/templates: `asm_bom`, `asm_up`, `asm_operation`, `asm_edm`, `edm_default`
- View to assign layer setting to. Use VIEW name to set display of layer in a specific view. Use `TOP_MODEL` to set display of layer on drawing sheet.
- Layer name whose display status is to be set
- Display status: Set YES to show layer; Set NO to hide layer

# Fixed Error

What

- Command “Attach” fails for quilts with multiple contours
- <https://redmine.buw-soft.de/issues/11708>

Why

- Starting edges of the boundary loops are not found correctly

Resolution

- Issue is fixed

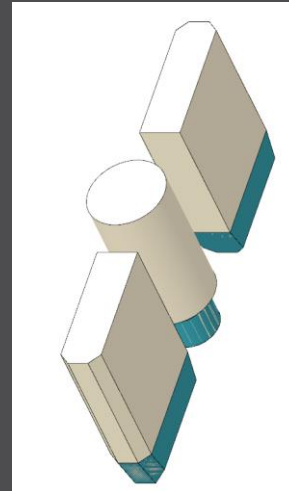
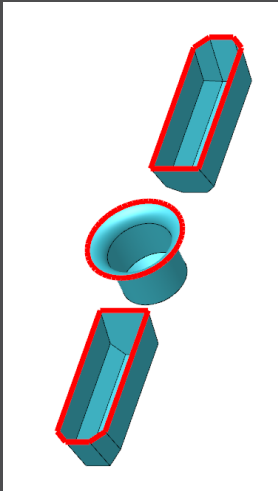

Attach



# Fixed Error

## What

- Project UI - skip models without solids during project creation
- <https://redmine.buw-soft.de/issues/11548>

## Why

- Regeneration error occurs if copy-geom, inheritance or merge feature is created for a model without solid geometry

## Resolution

- Models without solid will be skipped during creation of reference part
- An error message will be displayed

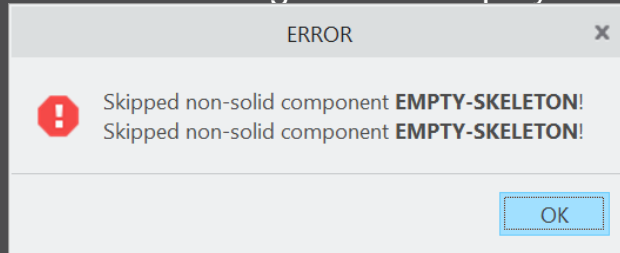

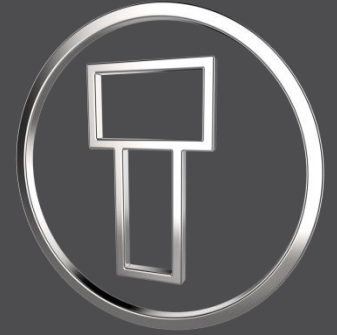

# SMARTElectrode 12.0.5.0

*What's New*



# Improvement

## What

- All configuration files are now considered as encoded in UTF-8
- <https://redmine.buw-soft.de/issues/10943>

## Why

- Necessary for updated interfaces to EDM

## How

- Please use a tool like Notepad++ to convert if necessary
- Files using ASCII standard characters don't need any special handling

# Improvement

## What

- Introduced 'Getting started' document
- <https://redmine.buw-soft.de/issues/10749>

## Why

- This document explains briefly how to start working with SMARTElectrode

## How

- Open 'Getting started' from
  - Installation directory
  - Download server:  
<https://dl.buw-soft.de/smartelectrode/guides/getting-started.pdf>
- Some of the topics covered
  - Configure license / Register and start SE
  - Setting up a configuration / How to use setup wizard
  - Creo options / SMARTElectrode Options
  - Workflow in SMARTElectrode
  - Parameters
  - Base UI
  - Customizing electrode templates
  - Drawing Creation

# Enhancement

## What

- Sort electrodes by parameter value before export
- <https://redmine.buw-soft.de/issues/10575>

## Why

- Some customers need to output electrodes in a specific sort order

## How

- Two new keywords can be used in any export configuration (export.cfg)
  - SE\_ORDER\_BY  
Define parameter by parameter name (1<sup>st</sup> column) or parameter default (last column; include &)
  - SE\_SORT\_ORDER  
Defines sort order: ASC, ASCENDING, DESC, DESCENDING
- Sorting works for strings, doubles and integers
- Only sort by part parameters!

```
SE_ORDER_BY · &BURNAREA_XY
SE_SORT_ORDER · DESCENDING
```

```
SE_ORDER_BY · BRENNFLAECHE
SE_SORT_ORDER · DESCENDING
```

```
BURNAREA · ID · NAME
361.980 · 11 · JS748100_AS_EDM_11
157.062 · 12 · JS748100_AS_EDM_12
156.671 · 12 · JS748100_AS_EDM_12
28.102 · 10 · JS748100_AS_EDM_10
28.102 · 10 · JS748100_AS_EDM_10
25.607 · 3 · JS748100_AS_EDM_03
```

# Improvement

## What

- Consider default action (include/exclude) of simplified representation when valid components for export are collected
- <https://redmine.buw-soft.de/issues/11020>

## Why

- Allow usage of master representation for example

## How

- All valid items in simprep are collected automatically by SMARTElectrode

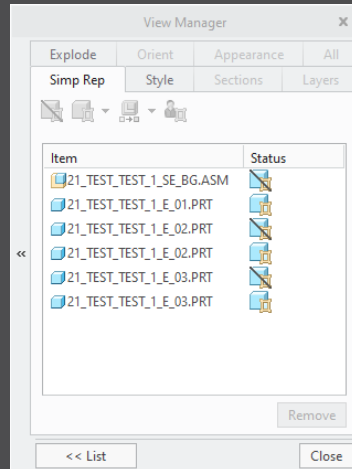



# Improvement

## What

- Updated advanced interface for Zimmer&Kreim Alphamoduli
- <https://redmine.buw-soft.de/issues/7864>

## How

- Processor files include upated list of orbits
- Additional supported XML tags in export
  - MeasDim
  - MeasProgType
  - MeasSizeX
  - MeasSizeY
  - MeasSizeZ
  - MeasZPointX
  - MeasZPointY
  - MeasZPointZ
  - EdgeDistance
  - SafetyDistance
- Please contact us for detailed information and setup!



ZK\_Deutsch.zip



ZK\_English.zip

# Improvement

## What

- Round contour height to even value in Base UI
- <https://redmine.buw-soft.de/issues/5550>

## Why

- For users more interested in an even contour height than in a rounded position

## How

- Mandatory settings:
  - INCREMENT\_POS = 0
  - INCREMENT\_SIZE > 0
- Height of contour will be rounded to a value, where
  - D1 corresponds at least to value in data file
  - D3 corresponds exactly to value in data file
  - Contour height is rounded to INCREMENT\_SIZE
- Should be combined with a free value
  - blank length (LENGTH = -1) or
  - base height (D2 = -1)

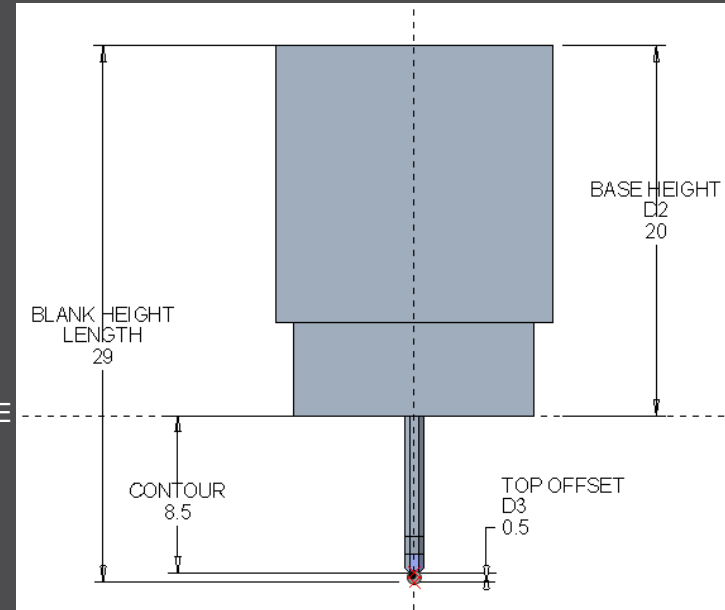

# Improvement

## What

- Show warning in Burnsheat UI if blank length is too small
- <https://redmine.buw-soft.de/issues/8494>

## Why

- Base is **NOT** changed by SMARTElectrode after creation
  - Position of base is retained
  - Size of base is retained
- User is in control whether the base must be revised
- Open Base UI to update values interactively
- Suppress base before Base UI is opened  
→ this starts automatic check and adjustment again

## How

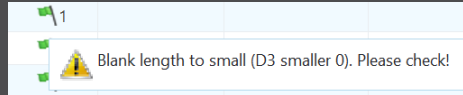

A_BASE	15.000		D1	1.000
B_BASE	15.000		D2	34.000
LENGTH	37.155		D3	-0.700
CHAMFER	<input type="checkbox"/>	Blank length to small (D3 smaller 0). Please check!		
FRAME	<input checked="" type="checkbox"/>	3.200		1.000

# Improvement

## What

- Burnsheet UI / Output UI: electrodes are ordered by feature number per default
- <https://redmine.buw-soft.de/issues/10409>

## Why

- A distinctive electrode sequence is necessary for the output occasionally

## How

- Change order of electrodes in modeltree using drag and drop
- The first appearance of an electrode determines the order for the output

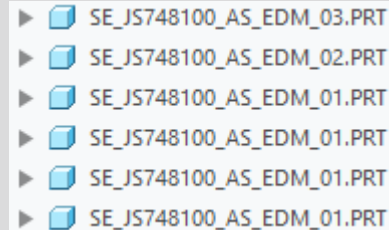

Order in modeltree

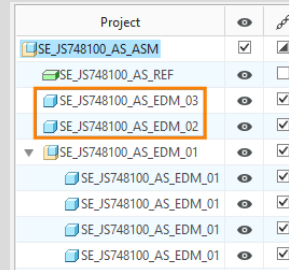

Order in Burnsheet UI

# Improvement

## What











- Show notifications for Burnsheat UI node on mouse-over
- <https://redmine.buw-soft.de/issues/10421>

## Why

- As a quick information for the user

## How

- Move mouse cursor over node if notifications available
- Click on notification to open detailed description in separate window and filter display

Project			Status
 38177-20_SE_BG	<input checked="" type="checkbox"/>	<input type="checkbox"/>	
 38177-20_SE_REF		<input type="checkbox"/>	
 38177-20-061		<input type="checkbox"/>	 1

 Base not centered on solid.

# Improvement

## What

- Use blank dimensions A\_BASE and B\_BASE for coverage check
- <https://redmine.buw-soft.de/issues/10622>

## Why

- CONTACT\_AREA\_MAX\_COVERAGE defines valid percentage of coverage
- SMARTElectrode used area of 'BASE\_TOP' leading to too small areas if clamp is part of electrode

## How

- SMARTElectrode evaluates blank area by base dimensions if available
- 'BASE\_TOP' surface may be used for imported electrodes
- More information about check of calculated burnarea projection:  
<https://redmine.buw-soft.de/issues/10622>

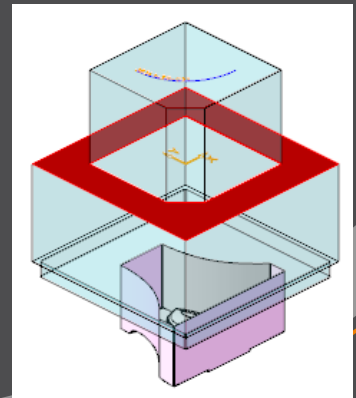

# Improvement

## What

- Allow cancelation of exact burnarea analysis on ESC
- <https://redmine.buw-soft.de/issues/10504>

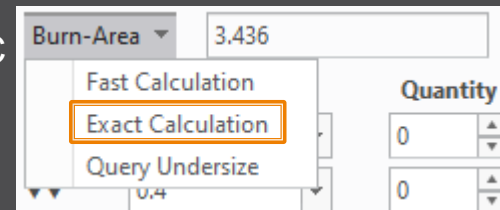

## Why

- Some surface types lead to lengthy analyzes

## How

- Press **ESC** during analysis in Base or Check UI to cancel calculation

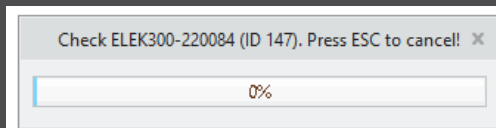

Options				
<input type="checkbox"/>	Interference	<input checked="" type="checkbox"/>	Touching Faces	
<input type="checkbox"/>	Assign Colors	<input type="checkbox"/>	Consider Undersize	
<input type="checkbox"/>	Calculate Undersize	<input checked="" type="checkbox"/>	Effective Contact Area	
Results				
?	Electrode	Touching Surface	Projection Area	Interference
<b>i</b>	SE_JS748100_AS_EDM_01		3.18557	✓
<b>i</b>	SE_JS748100_AS_EDM_01		3.18557	✓
<b>i</b>	SE_JS748100_AS_EDM_01		3.18557	✓
<b>i</b>	SE_JS748100_AS_EDM_01		3.18557	✓
<b>i</b>	SE_JS748100_AS_EDM_02	Cancelled	0	✓
	All	36	12.7423	0

# Improvement

## What

- Allow adjustment of assembly accuracy if inconsistent values are found
- <https://redmine.buw-soft.de/issues/10414>

## Why

- Same accuracy and type should be used in complete assembly
- Inconsistent accuracies may lead to errors

## How

- Warning will be displayed in assembly UI
- Input will be preset to smallest accuracy found
- Additional warning will be shown before creation of reference model
- Errors will be displayed afterwards

- **NOTE**  
SMARTElectrode does not change accuracy of the original models! This is because SE can't evaluate if change of accuracy is allowed.

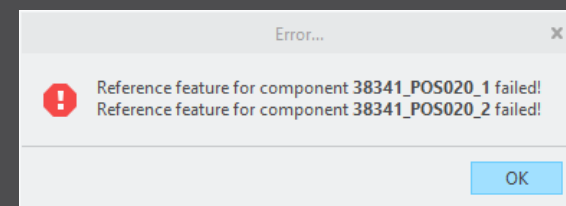
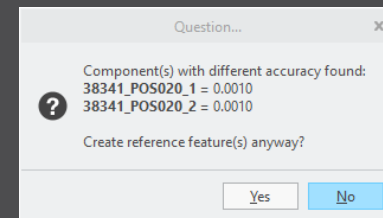
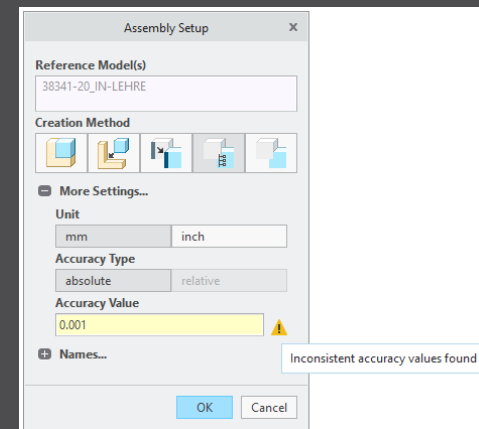



# Improvement

## What

- Use Flexible Modeling 'Substitute' in 'ATTACH' instead of replace
- <https://redmine.buw-soft.de/issues/8703>

## Why

- Normal offset-replace (modeling tab) does sometimes **NOT** unite electrode contour and electrode base, no matter whether FREE\_FACE or solid surface is selected as reference.

## How

- SMARTElectrode automatically uses feature substitute in group 'ATTACH' instead of offset/replace if license for Flexible Modeling Extension is available

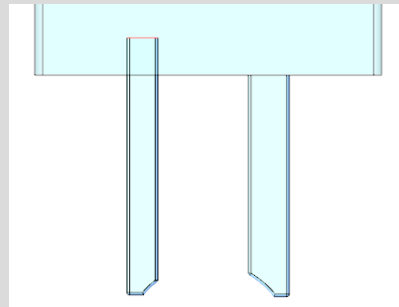

Result for expand

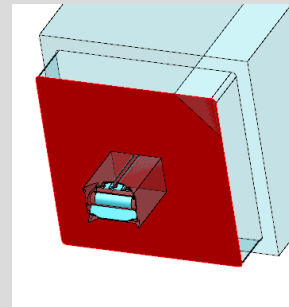

Result for replace

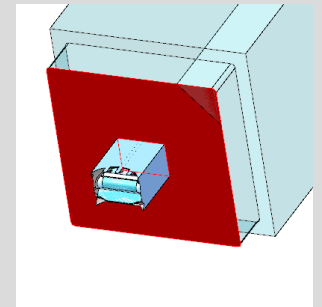

Result for FMX substitute

# Improvement

## What

- Handle existing base for commands 'Pattern' and 'Mirror' in design mode
- <https://redmine.buw-soft.de/issues/8495>



## Why

- Mirror of complete electrode including base may remove chamfers

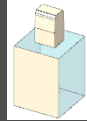

## How

- Command 'Pattern' automatically collects all solid surfaces or surfaces below FREE\_FACE

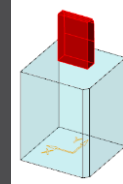

- Command 'Mirror' automatically activates insert mode and adds mirror feature in front of base

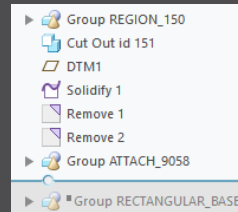

# Improvement

## What

- New commands 'Open Drawing' and 'Open Manufacturing' added to context menu in modeltree and object window
- <https://redmine.buw-soft.de/issues/10411>

## Why

- Easier navigation in electrode assembly

## How

- Commands are only accessible when assembly is active
- Commands are accessible for selected electrode in modeltree and graphics window
- Drawing and manufacturing will be opened in a new window
- If electrode is part of assembly drawing then correct sheet will be shown

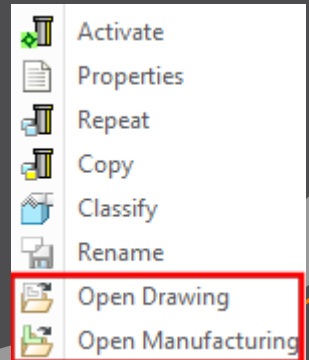

# Improvement

## What

- Introduced new command 'Open Configuration'
- <https://redmine.buw-soft.de/issues/10739>

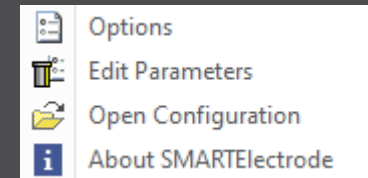

## Why

- Easier access to active configuration

## How

- A file browser opens in active configuration folder
- Actions for selected files / file types
  - parameter.cfg  
Dialog for modification will be opened
  - options.cfg  
Dialog for modification will be opened
  - \*.prt, \*.asm, \*.drw  
Creo file will be opened in a new window
  - any other file  
File will be opened in info window

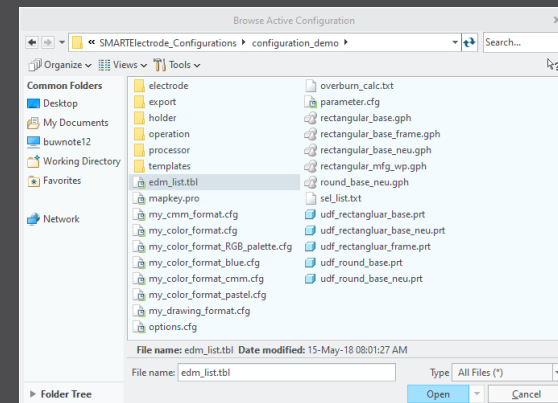

# Improvement

## What

- Disable automatic update of csys on workpiece sides
- <https://redmine.buw-soft.de/issues/10511>

## Why

- User should be in control when dependent operations and electrodes are updated

## How

- The 8 datum points represent the corners of the workpiece outline and can be used for drawing dimensions. These will be updated automatically!
- A notification will be shown in Burnsheat UI for outdated csys
- Double-click in notification details to update csys, operation and electrodes

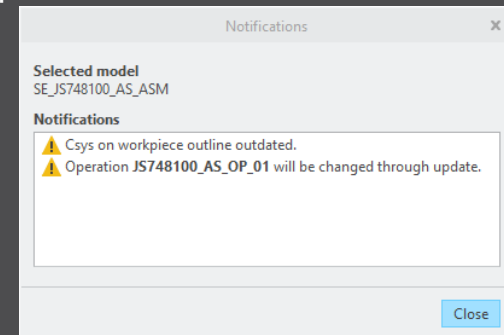
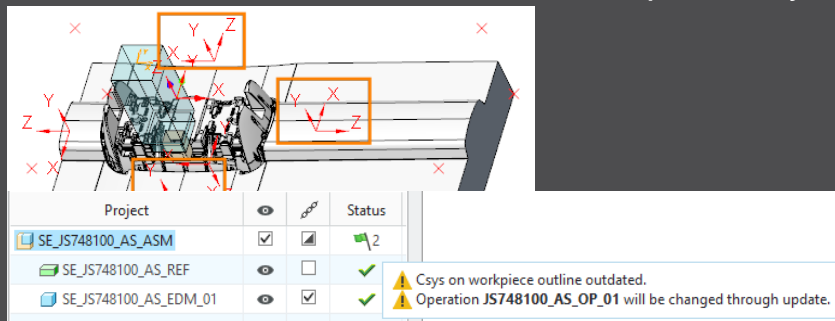
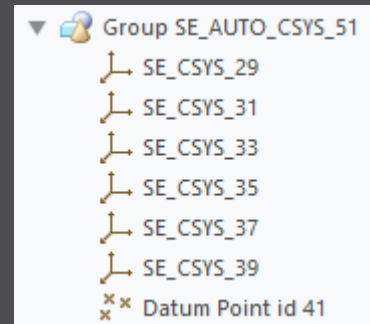

# Improvement

## What

- Repeat UI: only show selected electrodes and preview components when defining new position.
- <https://redmine.buw-soft.de/issues/10399>

## Why

- Improve overview for users if there are many electrodes assembled

## How

- Pre-select electrodes before Assemble Again UI is opened
- Or select in UI (don't forget to confirm selection)
- All electrodes are displayed again on OK or when user starts selection again

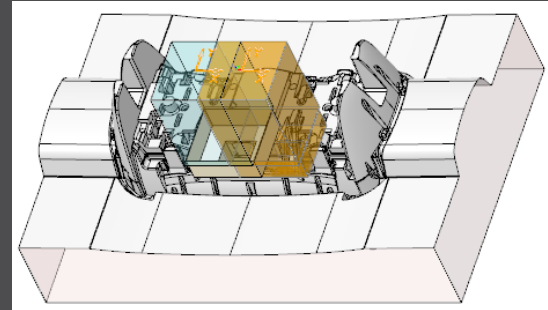
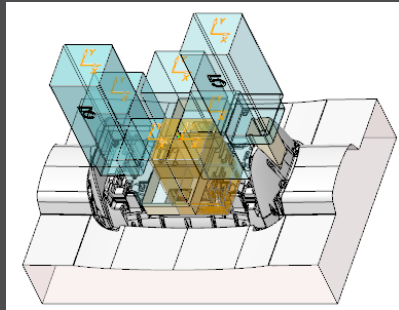

# Improvement

## What

- Use default csys from base to calculate angles
- <https://redmine.buw-soft.de/issues/10822>

## Why

- In some cases, it may be necessary to rotate csys with EDM\_ORIGIN\_NAME
- Angles in burnsheet would appear with wrong values
- Use csys showing orientation of blank for calculation of angles
- Always uses 'EDM\_ORIGIN' for electrodes designed in SMARTElectrode 7.0
- Always uses csys 'SE\_EDM\_BASE' or csys defined in option 'EDM\_ORIGIN\_NAME' for electrodes designed in SMARTElectrode 8.0 – 12.0

## How

- This allows adjustment of csys 'EDM\_ORIGIN\_NAME' for easier definition of start position

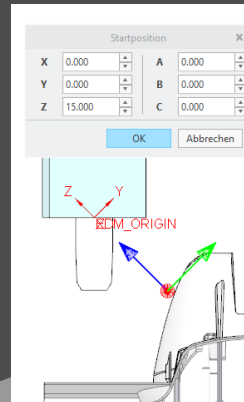
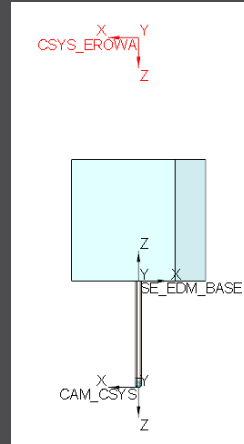

# Improvement

## What

- Allow subgroups in definition of user-defined features for electrode base.
- <https://redmine.buw-soft.de/issues/10389>

## Why

- Sometimes features are nested in groups (MEASURE\_FRAME, FRONT\_NUMBER, FREE\_FACE\_NUMBER) in Base UDF
- These features are currently not considered as part of the base leading to wrong size calculation
- SMARTElectrode now checks all features in base group when checking if a feature/surface is part of base or not.

## How

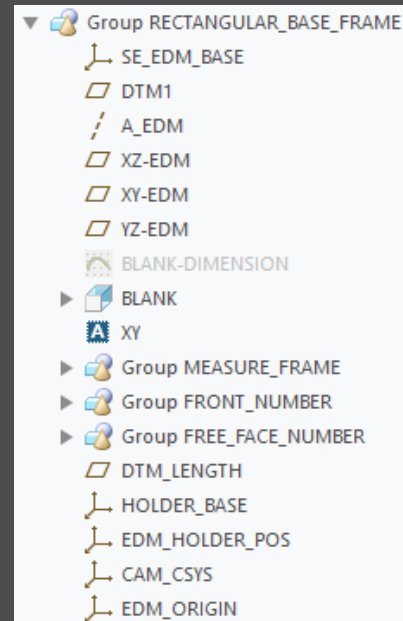



# Improvement

## What

- Check if feature merge in group 'Attach' creates a closed quilt if performed on surface feature or quilt

## Why

- Sometimes merge sets wrong side for 2<sup>nd</sup> quilt to keep
- Leads to an opened quilt which can't be solidified

## How

- SMARTElectrode checks if merge leads to a closed quilt
- SMARTElectrode changes side to keep in merge feature if necessary

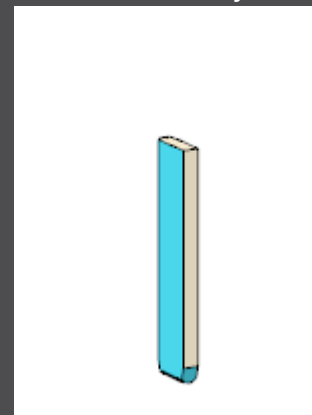
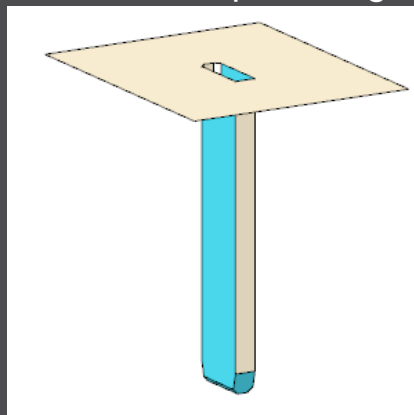
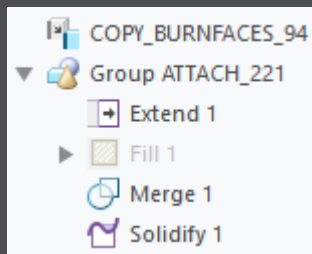

# Fixed Error

## What

- Prevent deletion of active operation
- <https://redmine.buw-soft.de/issues/10733>

## Why

- SMARTElectrode ribbon is disabled after deletion of active operation
- Most of the commands are still accessible but won't work anymore

## Resolution

- SMARTElectrode checks features whether they belong to active operation before deletion
- Deletion will be canceled with message window if feature of active operation selected

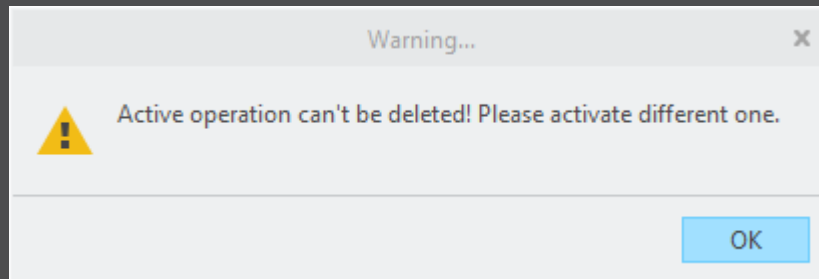

# Fixed Error

## What

- Electrode base with user-defined FREE\_FACE is suppressed to make design changes
- Base is reset to default position when resumed in Base UI

## Why

- Information about user-defined FREE\_FACE gets lost
- SMARTElectrode carries out default process to update base

## Resolution

- SMARTElectrode checks reference of datum FREE\_FACE for changes
- Recognition works for all models with user-defined FREE\_FACE

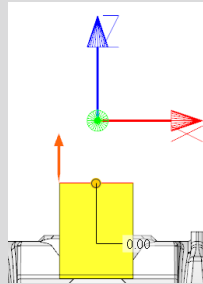

Selected user-defined  
FREE\_FACE

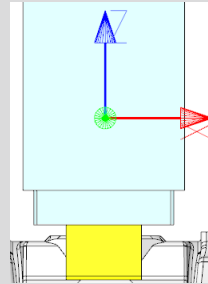

Error on resume in Base  
UI

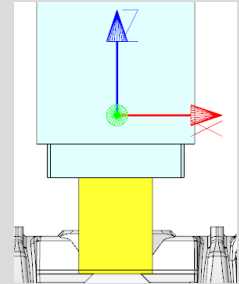

Fix: position is retained

# Fixed Error

## What

- Workpiece dimensions on drawing sometimes incomplete
- <https://redmine.buw-soft.de/issues/10990>

## Why

- Orientations are sometimes not correctly set after drawing creation from template
- For these drawing views sorting of outline points might fail

## How

- Supported symbolic names for drawing orientations
  - 2d view names: SE\_TOP (SE\_DEFAULT), SE\_BOTTOM, SE\_FRONT, SE\_BACK, SE\_LEFT, SE\_RIGHT
  - 3d view names: SE\_DEFAULT\_ISO, SE\_ASM\_DEFAULT, SE\_ASM\_ISO
- Please refer to 'Getting started' document in installation for more information

# Fixed Error

## What

- Fixed wrong creation of ordinate dimensions on drawings
- <https://redmine.buw-soft.de/issues/10685>

## Why

- Multiple redundant baselines without merging dimensions have been created

## How

- This issue is fixed

# Fixed Error

## What

- Reset surface appearance to default before touching faces are colored
- <https://redmine.buw-soft.de/issues/10405>

## Why

- Reset of surface colors is not applicable in all cases

## How

- COLOR\_EDM\_TOUCHING\_FACES has to be available in my\_color\_format.cfg
- A warning will be displayed if 'COLOR\_EDM\_TOUCHING\_FACES' is not applicable
- A distinction is made between the following cases:
  - Check UI: coloring can be done when all electrode positions are selected for touching surface analysis
  - Check UI: a warning will be displayed and coloring will be canceled if NOT all electrode positions are selected for touching surface analysis
  - Base UI: coloring can be done in detailed calculation of contact area if active electrode is used only once in assembly
  - Base UI: a warning will be displayed and coloring will be canceled if active electrode is used multiple times in assembly

# Fixed Error

What

- Fixed wrong result for selection by color
- <https://redmine.buw-soft.de/issues/10857>



Why

- Sometimes too many surfaces have been selected

Resolution

- This issue is fixed

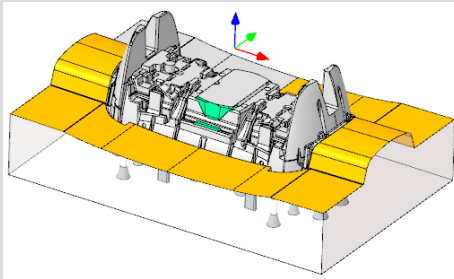

Original

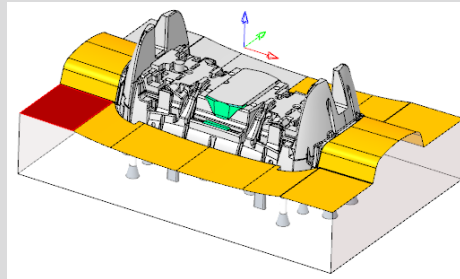

Selected reference

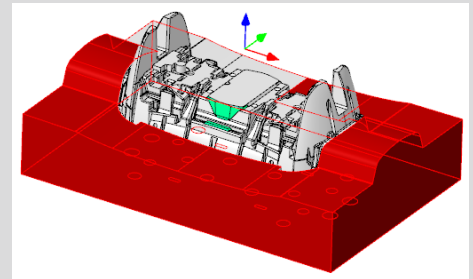

Wrong result

# Fixed Error

## What

- Hide invalid commands in modeltree
- <https://redmine.buw-soft.de/issues/10985>

## Why

- Some commands are invalid in modeltree context menu if selected feature is not inside active component

## How

- This issue is fixed



# Fixed Error

## What

- Commands can be selected from context menu for suppressed electrodes
- Applies to Creo Parametric 4.0 and 5.0
- <https://redmine.buw-soft.de/issues/10518>

## Why

- Component selections are not automatically skipped in above Creo versions

## Resolution

- Issue is fixed
- Commands are removed for suppressed features

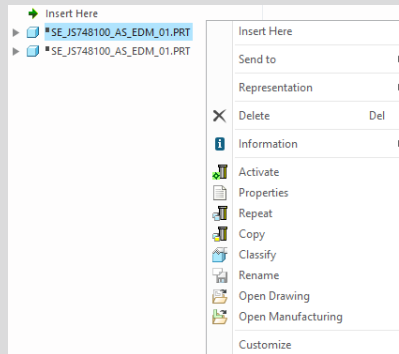

Before

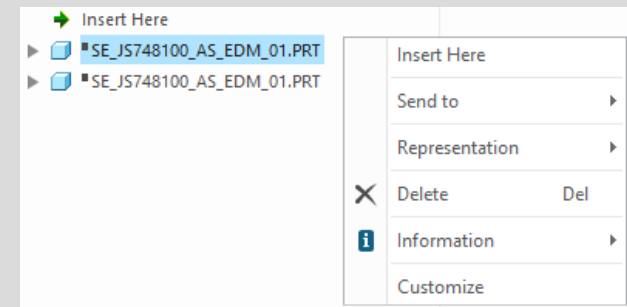

After

# Fixed Error

## What

- Crash in Base UI if no workpiece model found
- <https://redmine.buw-soft.de/issues/10488>

## Why

- It's not possible to read workpiece information if no component in assembly is marked as workpiece
- Parameter `SE_CORE_MODEL=1` not available

## Resolution

- Issue is fixed
- Always check if an active workpiece can be found and cancel functionality if necessary

# Fixed Error

## What

- Command 'New with Base' does not work anymore
- <https://redmine.buw-soft.de/issues/10407>

## Why

- SMARTElectrode checks selected template for completeness before its used
- This includes check for parameters
  - SE\_EDM\_SUPPLIER
  - SE\_EDM\_TYPE
- Command is canceled if any expected parameter is missing

## Resolution

- Issued is fixed
- SMARTElectrode extracts supplier and type from selected data file:  
configuration/electrode/<supplier>/<type>.dat

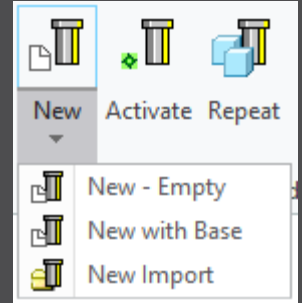

# Fixed Error

## What

- Help does not open if path contains spaces or special characters.

## Resolution

- Issue is fixed.

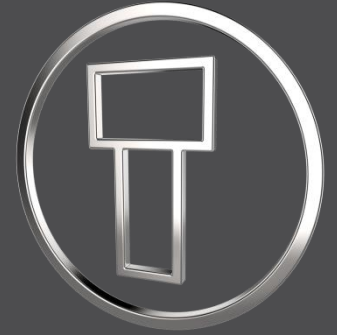

# SMARTElectrode 12.0.4.0

*What's New*



# Improvement

## What

- Added threshold to show a warning if contact area covers more than defined percentage of blank area  
[\[https://redmine.buw-soft.de/issues/10357\]](https://redmine.buw-soft.de/issues/10357)

## Who needs it

- Users who output effective contact area for EDM programming

## Details/Usage

- SE performs a fast contact area calculation when Base UI is opened and contact area is 0
- Slower more exact calculation can be started by user in UI
- Check UI always performs the exact calculation
- Option “CONTACT\_AREA\_MAX\_COVERAGE” defines valid percentage
- Warnings are shown in Base UI and Burnsheets notifications

CONTACT_AREA_MAX_COVERAGE	80	Maximum valid coverage of the blank area with contact areas in percent.
---------------------------	----	-------------------------------------------------------------------------

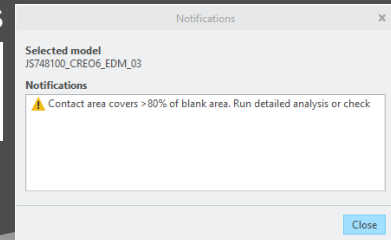
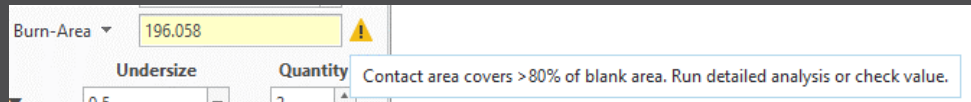

# Fixed error

## Description

- Edited base values are reset on next change  
[\[https://redmine.buw-soft.de/issues/10218\]](https://redmine.buw-soft.de/issues/10218)

A_BASE	17.500	▲▼	D1	5.128	▲▼
B_BASE	15.000	▲▼	D2	40.000	▲▼
LENGTH	48.000	▲▼	D3	0.022	▲▼

A_BASE	15.000	▲▼	D1	5.128	▲▼
B_BASE	15.000	▲▼	D2	35.000	▲▼
LENGTH	43.000	▲▼	D3	0.022	▲▼

## Cause

- Edited values are not correctly saved to template data

## Solution

- Problem is fixed

# Fixed error

## Description

- Some electrodes are not processed during output [<https://redmine.buw-soft.de/issues/10191>]

## Cause

- SE validates every electrode during export and skips suppressed, disabled or incomplete components.
- Check for completeness includes a check of electrode base group
- Check for completeness fails on imported or legacy electrodes as base is not created by UDF.

## Solution

- SE now looks for existence of mandatory EDM coordinate system
- Legacy electrode use “EDM\_ORIGIN” or “EDM\_ORIGIN\_TOP” depending on option value “USE\_POS\_CSYS\_TOP”
- Electrodes beginning with version 8.0 use csys name defined in option “EDM\_ORIGIN\_NAME”





# SMARTElectrode 12.0.3.1

*What's New*



# Fix: Export options not working

## What

- Export options SE\_DECIMAL\_SEPARATOR and SE\_EXPORT\_GAP

## Description

- This option settings are ignored during output

## Solution

- Issues are fixed
- Use SE\_DECIMAL\_SEPARATOR to set . or , as decimal separator in output.
- Use SE\_EXPORT\_GAP to convert undersize values for output
  - 0: uses overburn value without conversion (1:1)
  - 1: duplicates overburn value (2:1)
  - 2: halves overburn value (1:2)

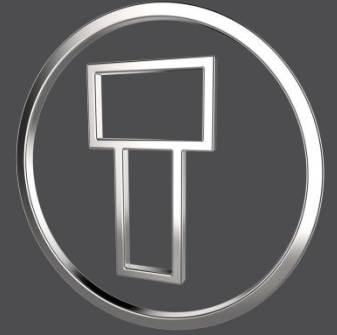

# SMARTElectrode 12.0.3.0

*What's New*



# Enhancement: Separate Templates

## What

- Allow separate templates for all model types in SMARTElectrode. These templates will be used instead of default templates in Creo Parametric.

## Who needs it

- Use separate templates to preset additional parameters and layers or to realize MBD-settings

## Details/Usage

Available templates:

- Electrode assembly: `configuration\model\se_assembly.`
- Reference assembly: `configuration\model\se_reference.asm`
- Reference part: `configuration\model\se_reference.prt`
- Electrode: `configuration\model\se_electrode.prt`
- Analysis model: `configuration\model\se_analysis.prt`
- Manufacturing assembly: `configuration\model\se_mfg.asm`
- Workpiece: `configuration\model\se_mfg_workpiece.prt`

# Improvement: Blank Selection

## What

- Improved automatic selection of blank if different lengths are available for same section.

## Who needs it

- Useful if blanks with fixed size and length are prepared in data files

## Details/Usage

- Electrode blanks are defined in configuration\electrode\- Add several lengths for a blank size. For example:
  - 15x15x50
  - 15x15x75
  - 15x15x100
- SMARTElectrode tries to select best fitting template when base is created

# Save Export to Workspace

## What

- Created output files can be saved to workspace automatically now

## Who needs it

- Necessary if all manufacturing information is passed via PDMLink

## Details/Usage

- To activate this feature open export configuration file  
configuration\export\<<format name>\export.cfg
- Add option “WM\_COPY\_TO\_WORKSPACE YES” to add document as primary content
- Add option “WM\_ADD\_AS\_SECONDARY\_CONTENT YES” if document should be attached to electrode assembly as secondary content.

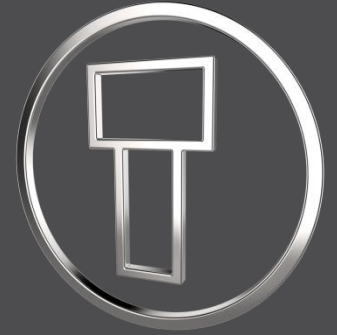

# SMARTElectrode 12.0.2.0

*What's New*



# Enhancement: UI Start Position

## What

- Interactively define the start position of electrode
- Command is available if electrode component is activated

## Who needs it

- Users who want to optimize start positions for EDM

## Details/Usage

- Defined start position overrides default start position and csys feature STARTPOS in electrode model

- Learn more:
- <https://www.buw-soft.de/en/2020/02/21/new-user-interface-start-position/>
- <https://youtu.be/254n3AtqQDA>

Axis	Value
X	0.000
Y	0.000
Z	0.000
A	0.000
B	0.000
C	0.000



# Enhancement: Selection by Toolpath

## What

- New tool to interactively check manufacturability and select surfaces

## Who needs it

- Customers who want to select surfaces with a brush styled tool
- Helps to capture even small patches within path

## Details/Usage

- Learn more:
- <https://www.buw-soft.de/en/2020/02/21/new-selection-tools-for-electrodes/>
- <https://youtu.be/OctjK6Usgo8>

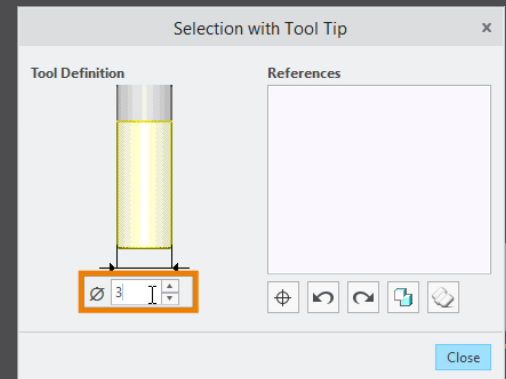
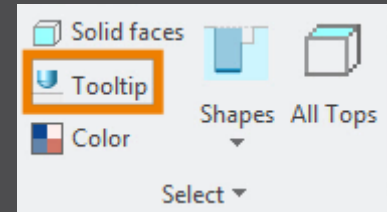

# Improvement: Shape-based Selection

## What

- Integrated Shape-based selection filters from Flexible Modeling Extension in electrode design ribbon

## Who needs it

- Customers who want to use FMX features

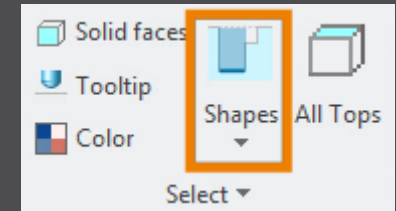

## Details/Usage

- Learn more:
- <https://www.buw-soft.de/en/2020/02/21/new-selection-tools-for-electrodes/>
- <https://youtu.be/OctjK6Usgo8>

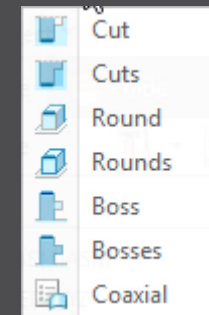

# Dynamic Editing of Cutout

## What

- Size and position can be changed dynamically after selecting the geometry

## Who needs it

- Customers who want to interactively change cutout

## Details/Usage

- Learn more:
- <https://www.buw-soft.de/en/2020/02/21/dynamic-editing-of-cutout-features/>
- <https://youtu.be/hg2yxot2-bo>

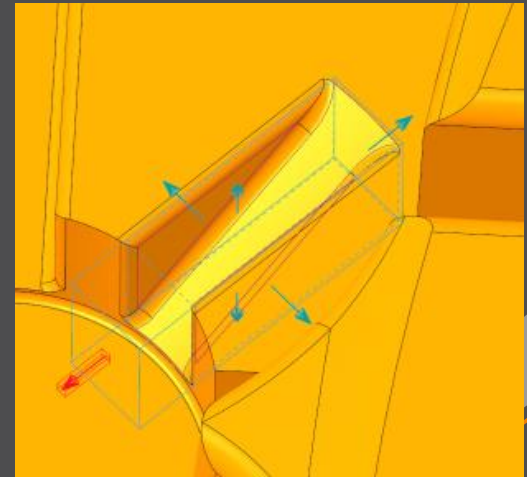

# Workpiece dimensions on drawing

## What

- Add workpiece dimensions to any drawing sheet

## Who needs it

- Customers who want to create workpiece dimensions on electrode documentation

## Details/Usage

- Update of my\_drawing\_format.cfg necessary to use this feature
- Learn more:
- <https://www.buw-soft.de/en/2020/02/21/add-workiece-dimensions-automatically/>
- [https://youtu.be/iH1Ou\\_HutEY](https://youtu.be/iH1Ou_HutEY)

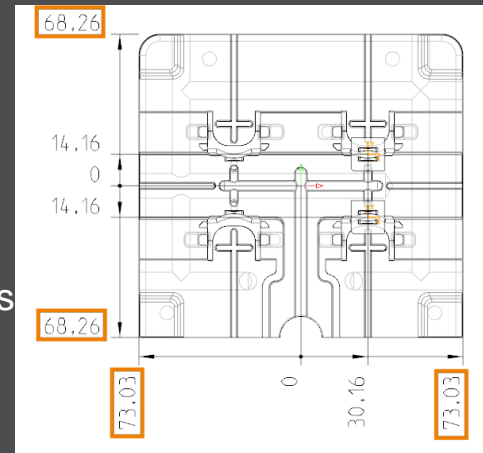

# Improvement: Import 3rd party EDM

## What

- New import workflow is available for Creo part files or neutral formats STEP/IGES
- SMARTElectrode adds datums to imported electrode to enable most of the functionality

## Who needs it

- Customers who need to work with existing electrodes not designed in SMARTElectrode

## Details/Usage

- Due to the variety of design approaches, there may be restrictions in use
- Learn more:
- <https://www.buw-soft.de/en/2020/02/21/improved-workflow-for-import-of-third-party-electrodes/>
- <https://youtu.be/vq-TaOuVh8>

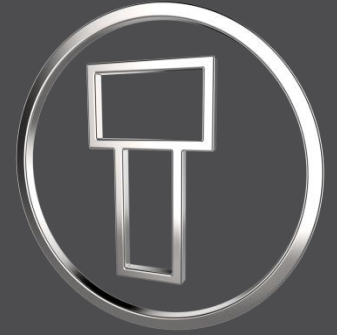

# SMARTElectrode 12.0.1.3

*What's New*



# Enhancement: Redefine Operation

## What

- Electrode position data is automatically updated if zero point is redefined interactively

## Who needs it

- Customers who prefer to incorporate changes without opening the UI

## Details/Usage

- Learn more:
- <https://www.buw-soft.de/en/2019/11/18/automatic-update-when-operation-zero-is-changed/>
- <https://youtu.be/1M9pefJJyWA>

# Notifications in Burnsheat

## What

- Introduced additional notifications in Burnsheat UI

## Who needs it

- Users who want to evaluate electrode status

## Details/Usage

- Learn more:
- <https://www.buw-soft.de/en/2019/11/18/notifications-in-burnsheet/>
- <https://youtu.be/7MqPr5hVnEI>



# Improvement: Multiprog Output

## What

- Added output of electrode type

## Who needs it

- Customers using output for Ingersoll Multiprog

## Details/Usage

- Learn more:
- <https://www.buw-soft.de/en/2019/11/18/data-output-improvements-for-ingersoll/>

# New Templates for Creo NC

## What

- Empty template MFG\_DEFAULT
- Template for 3-axis milling MFG\_3AXIS
- Template for ModuleWorks MFG\_MODULEWORKS

## Who needs it

- Customers who do NC programming in Creo

## Details/Usage

- Learn more:
- <https://www.buw-soft.de/en/2019/11/18/new-manufacturing-templates-for-use-with-creo-nc/>

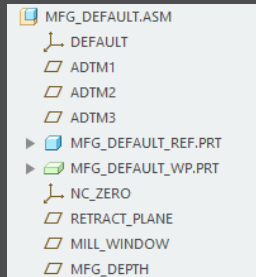

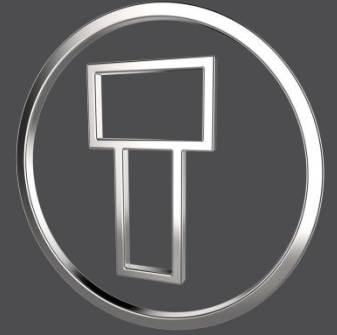

# SMARTElectrode 12.0.0.0

*What's New*



# Enhancement: UI Post-Processor

## What

- Added a new user interface to output data for EDM
- All custom formats are still accessible in output UI
- Several controls/formats like AC Form, AgieVision, Ingersoll Multiprog, Makino EPX, Exeron Exoprog, Zimmer & Kreim, ... can be offered on request

## Who needs it

- Customers who want to simplify and speed up EDM programming

## Details/Usage

- UI is accessible in ribbon UI
- Select control/format, object for export and start with 'Create'

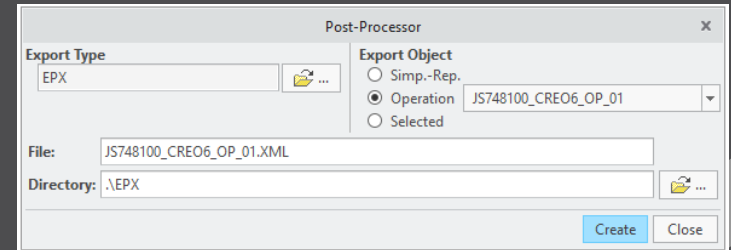
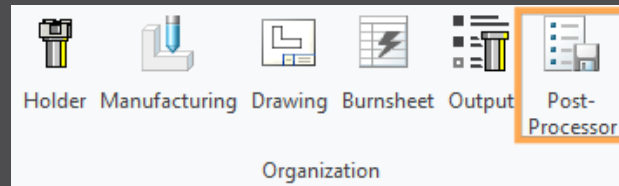

# Enhancement: UI Cutout

## What

- Added a new user interface define or redefine the solid for cutout
- Position, size and rotation can be adjusted in

## Who needs it

- Customers who need to set size/position of solid

## Details/Usage

- Start definition via ribbon or context menu
- Start redefinition via context menu in modeltree
- UI replaces 'user-defined cutout'

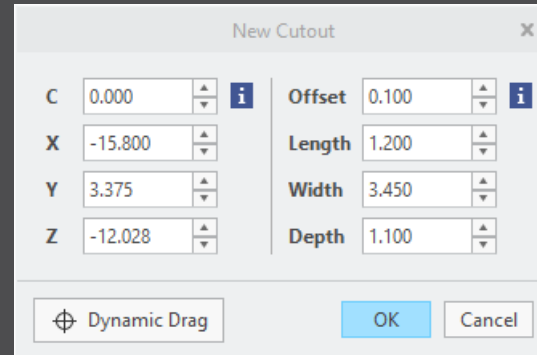
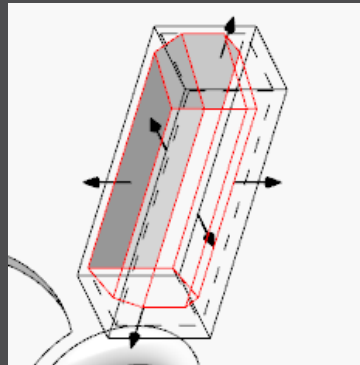
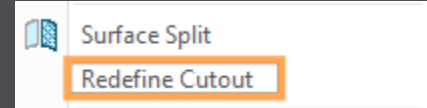

# Enhancement: Redefine Assembly

## What

- Definition of electrode assembly can be changed

## Who needs it

- Customers who need to add or remove models from definition of reference parts

## Details/Usage

- Start redefinition via ribbon
- More functionality like renaming of assembly may be added later

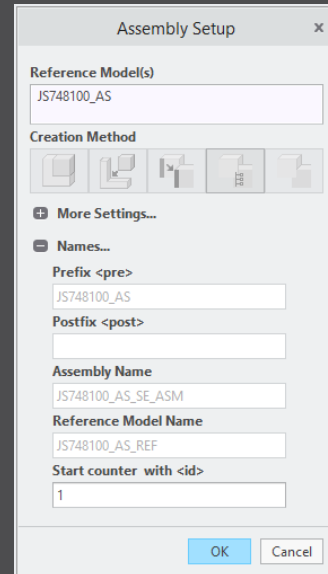
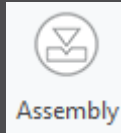
A screenshot of a software dialog box titled "Assembly Setup". The dialog has a title bar with a close button (x). It contains several sections: "Reference Model(s)" with a text field containing "JS748100\_AS"; "Creation Method" with five icons representing different assembly methods; "More Settings..." with a plus sign; "Names..." with a minus sign, containing fields for "Prefix <pre>" (JS748100\_AS), "Postfix <post>" (empty), "Assembly Name" (JS748100\_AS\_SE\_ASM), "Reference Model Name" (JS748100\_AS\_REF), and "Start counter with <id>" (1). At the bottom right are "OK" and "Cancel" buttons.

# Improvement: Burn-Area in Base UI

## What

- Added effective contact area and workpiece material to Base UI

## Who needs it

- Customers who need calculated and output contact area
- Customers who get undersize/burngap from database

## Details/Usage

- SMARTElectrode performs a fast calculation if no burn-face value available
- Exact calculation can be started using the Burn-Area menu
- Calculation of undersize values can also be started directly from this UI
- Definition of values in overburn\_calc.txt necessary to use 'Query Undersize'

Workpiece	ST37
Material	Graphite
Quality	-
Burn-Area	3.93559
Fast Calculation	Quantity
Exact Calculation	1
Query Undersize	1

# Improvement: Output Files

## What

- Exports are named like selected operation by default

## Advantage

- This allows export of operations one after another without changing the name interactively

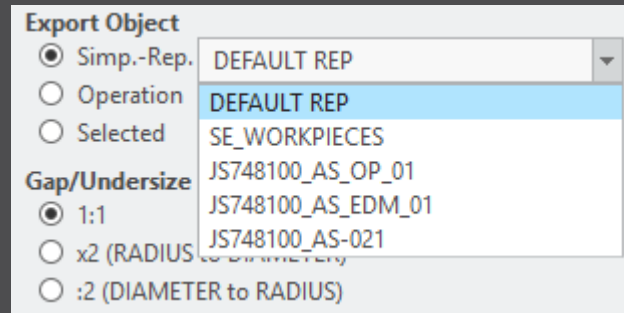



# Improvement: Simpreps in Output UI

## What

- Allow output by simplified representation

## Who needs it

- Customers who want to output a subset of electrodes

## Details/Usage

- Use simplified representations for repair or new electrodes necessary through design change

