

SMARTElectrode 13.0.2.0

What's New



Enhancement

What

- Allow surface models as workpieces
- <https://redmine.buw-soft.de/issues/11584>

Why

- Workpieces are sometimes only available as surface models and can't be repaired via Import Data Doctor (IDD)

How

- Use method "original models" to create assembly from surface models
- SMARTElectrode offers support for:
 - Workpiece: outline calculation of workpieces
 - Operation: offset calculation in operation definition
 - Design: cutout creates a solid and a solidify feature if referenced workpiece is a surface model. Solidify may fail if quilt includes gaps.
 - Analysis: touching surface analysis for effective contact area
- **NOTE** computation of interference is unavailable for surface models. A warning will be displayed in Check UI

Interference

⚠ Workpiece TUTORIAL3_OFFEN is surface model. No calculation possible!

⚠ Workpiece TUTORIAL3_OFFEN is surface model. No calculation possible!

Enhancement

What

- Introduced layer definition in my_drawing_format.cfg to control display status
- <https://redmine.buw-soft.de/issues/10575>

Why

- It's a tedious task to set correct layer display on electrode drawings

How

- Add section enclosed with .BEGIN_LAYERS and .END_LAYERS to my_drawing_format.cfg
- Define drawing template name, view, layer and display status in a tab separated table
- Drawing name from configuration\templates: asm_bom, asm_wp, asm_operation, asm_edm, edm_default
- View to assign layer setting to. Use VIEW name to set display of layer in a specific view. Use TOP_MODEL to set display of layer on drawing sheet.
- Layer name whose display status is to be set
- Display status: Set YES to show layer; Set NO to hide layer

Enhancement

What

- Electrode base can now also be added on a user-defined coordinate system
- <https://redmine.buw-soft.de/issues/8704>

Why

- To lock the position of the base on an axis
- To prepare a geometry pattern of the contour

How

- Define coordinate system in electrode
- Select coordinate system and open Base UI
 - Base will be added to coordinate system
 - Position of coordinate system is taken into account to calculate required blank size
- Base is locked to coordinate system. Delete base to use different option

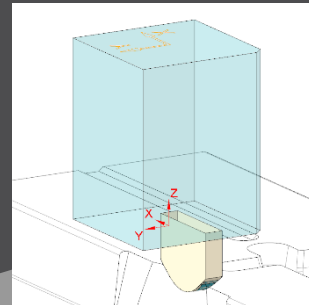
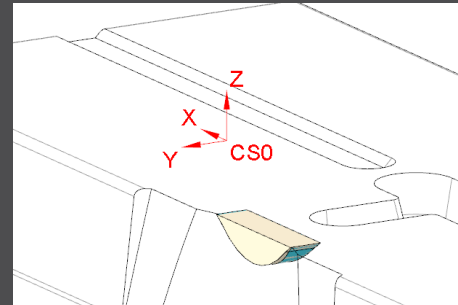
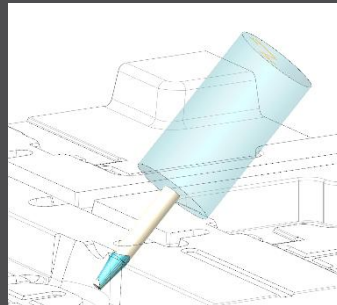
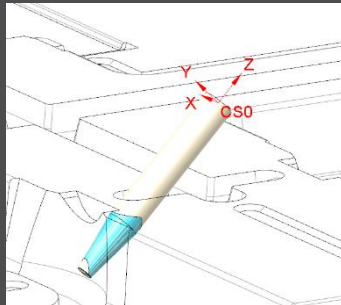

Enhancement

What

- Copy electrodes from existing electrodes or prepared templates
- <https://redmine.buw-soft.de/issues/11700>

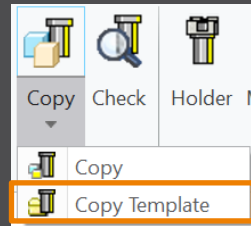

Why

- Allow reuse of...
 - incomplete electrode models to be completed inside assembly (for gate electrodes)
 - complete electrode models created without SMARTElectrode (for electrodes from stock)
 - complete electrode created with SMARTElectrode (for electrodes from different assembly)

How

- Csys defined in option SE_EDM_ORGIN_NAME is mandatory
- "configuration\electrode\templates" is used as default path to select templates
- Associated data (drawing, manufacturing) will be copied to new name also
- Controls in Base UI will be disabled if template is detected

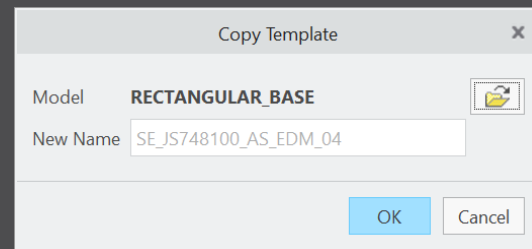

Improvement

What

- Electrode design mode:
Maintain definition of surface collections when creating copy-geoms
- <https://redmine.buw-soft.de/issues/11765>

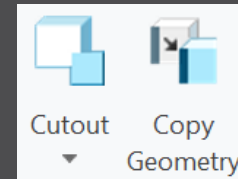

Why

- So far, a new copy-geom was created for each surface set on >Get Data >Cutout and >Get Data >Copy Geometry

How

- Surface sets in selection buffer are now automatically sorted by reference model
- All surface sets from same reference model will be added to same copy-geom feature

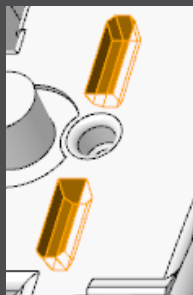

Set	Count	
Individual Surfaces	0	Add Remove
Seed and Boundary Surfaces	9	
Seed and Boundary Surfaces	9	
Excluded Surfaces	0	

Improvement

What

- Base UI - keep predefined holder offset if different holder is selected on details page
- <https://redmine.buw-soft.de/issues/10943>

Why



- Adapts behavior of Base UI to Holder UI. Offset / rotation will be retained if a different holder is selected

How

- Selection of new blank type or size updates holder and position

SIZE	35X35X60_025MM_1
A_BASE	25X85X60 25X85X60_025MM
B_BASE	25X85X60_100MM 35X35X60
LENGTH	35X35X60_025MM_1
CHAMFER	35X35X60_025MM_2

- Current position will be retained if a new model is selected on details page

Holder	
Supplier	EROWA
Type	F60000
	 Edit Position
	 Reset Position

- A new popup menu allows edit and reset of holder position

Interface to Ingersoll MultiProg

What

- Suppress output of generator types to ING file
- <https://redmine.buw-soft.de/issues/10943>

Why

- Set undersize values are mapped on generator types in output
- Some customers prefer output without generator types

	Undersize	Quantity
▼	0.5	2
▼▼	0.4	1
▼▼▼	0.30	1
▼▼▼▼	0.20	1

How

- Add option WRITE_GENTYPEL NO to export.cfg to suppress output
`WRITE_GENTYPEL · NO`
- File is located in configuration\processor\INGERSOLL\pp\export.cfg
- Generator types based on undersize values
 - RO: roughing
 - PF: prefinish
 - FI: finish
 - FF: fine finish

Interface to ZK Alphamoduli

What

- Calculate <SafetyDistance> based on electrode contour height and position of MEASZPOINT

- <https://redmine.buw-soft.de/issues/11881>

Why

- <SafetyDistance> uses a fixed value from export.cfg currently
- A calculation based on contour height is necessary

How

- Two options in export.cfg control behavior for <SafetyDistance>
 - SafetyDistance ... → fixed to be considered at the CMM.
 - SafetyDistanceOffset ... → offset for safety distance added to measured distance from blank length to MeasZPoint

- **Note**
Only use SafetyDistance or SafetyDistanceOffset!

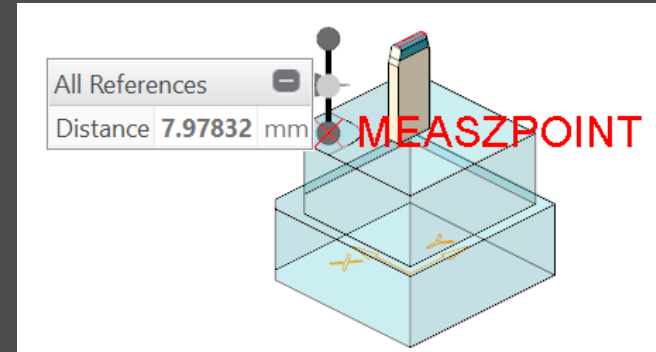

Interface to ZK Alphamoduli

What

- Allow alternative csys for output of measure information
- <https://redmine.buw-soft.de/issues/11585>

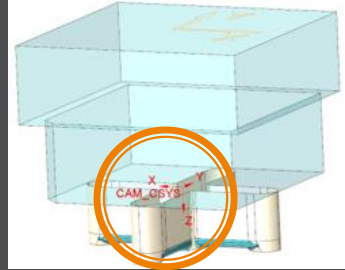
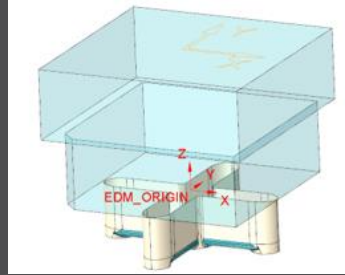

Why

- All measuring information like

```
<MeasSizeX>38.0000</MeasSizeX>
<MeasSizeY>38.0000</MeasSizeY>
<MeasSizeZ>0.0000</MeasSizeZ>
<MeasZPointX>-16.5000</MeasZPointX>
<MeasZPointY>-16.5000</MeasZPointY>
<MeasZPointZ>0.0000</MeasZPointZ>
<QMPoint>
...
</QMPoint>
```

- ... need to be output for csys with correct orientation
- Use setting “SE_EDM_BACKUP_CSYS” in export.cfg to set csys names
- Several alternative csys can separated by ;
- Option names will automatically be replaced by value

How

```
SE_EDM_BACKUP_CSYS · EL_CSYS; · CSYS_DEFAULT; · ANY_CSYS;
SE_EDM_BACKUP_CSYS · CAM_CSYS_NAME; · EDM_ORIGIN_NAME;
```

Interface to ZK Alphamoduli

What

- Add <MeasureProg> to XML output
- <https://redmine.buw-soft.de/issues/11659>

Why

- MeasureProg is the name of the learning/measuring program for the automatic presetting at the CMM

How

- A measure frame needs to be available to output <MeasureProg>
- Default values are:

```
<!-- default for rectangular frame: ESVierkant -->  
<MeasureProg>ESVierkant </MeasureProg>  
<!-- default for round frame: ESMitteKreis -->  
<MeasureProg>ESMitteKreis</MeasureProg>
```

- Custom names for <MeasureProg> can be defined in parameters
 - Parameter configuration
MEASUREPROG PART STRING N N 10 N Y &measureprog
 - Selection list in sel_list.txt
#MEASUREPROG
...

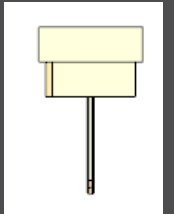
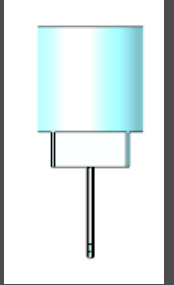

Interface to ZK Alphamoduli

What

- Suppress `<MeasProgType>` and `<MeasSize...>` if no frame available
- <https://redmine.buw-soft.de/issues/11537>
- <https://redmine.buw-soft.de/issues/11587>

Why

- `<MeasProgType>` and `<MeasSize...>` are only valid if a measuring frame is available in blank
- Output is suppressed if frame is not found

```
<MeasProgType></MeasProgType> > empty  
<MeasSizeX></MeasSizeX> > skipped  
<MeasSizeY></MeasSizeY> > skipped  
<MeasSizeZ></MeasSizeZ> > skipped
```

- Example electrodes without frames:

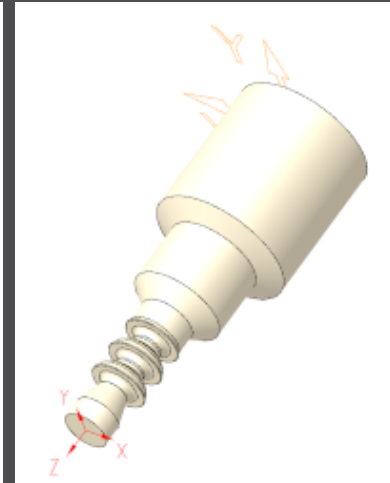
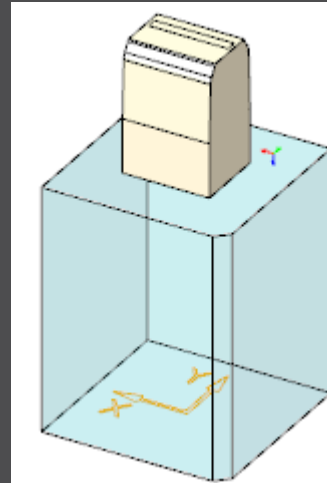

Interface to ZK Alphamoduli

What

- Allow custom name for MeasZPoint in export settings
- <https://redmine.buw-soft.de/issues/11586>

Why

- MeasZPoint is the datum point where Z-height should be measured
- Datum point may be available in customer templates with different name

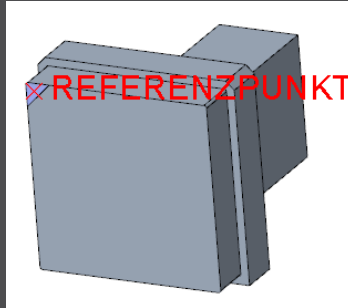

How

- Add option MeasZPoint <name> to export.cfg
 - An existing datum point named “MEASZPOINT” will be renamed on export
- ```
! · name · of · datum · point · feature · to · use · for · MeasZPoint
MeasZPoint · MEASZREF
```
- **NOTE** Datum point needs to be reachable!

# Interface to ZK Alphamoduli

## What

- Name format options to shorten names in XML output
- <https://redmine.buw-soft.de/issues/11855>

## Why

- Depending on EDM machine setup length of 32 characters may **not** be available for electrode names in XML
- Creation of shorter names is required

## How

- Naming options SE\_EDM\_NAME\_FORMAT and SE\_2<sup>ND</sup>\_EDM\_NAME\_FORMAT introduced. Examples:
  - SE\_EDM\_NAME\_FORMAT EDM\_<ID>
  - SE\_2<sup>ND</sup>\_EDM\_NAME\_FORMAT <partname><any known parameter>

```
<LogEle LogGroup=„SE_EDM_NAME_FORMAT“>
 <Name>SE_EDM_NAME_FORMAT</Name>
 <Remark>SE_2ND_EDM_NAME_FORMAT</Remark>
 <DocList>
 <Document>
 <Name>SE_2ND_EDM_NAME_FORMAT</Name>
 <File>SE_2ND_EDM_NAME_FORMAT</File>
 </Document>
 </DocList>
</CadModel>SE_2ND_EDM_NAME_FORMAT</CadModel>
```

# Fixed Error

## What

- Assignment of combined states to drawing views fails sometimes
- <https://redmine.buw-soft.de/issues/10772>

## Resolution

- Replaced combined states with a list of layer definitions which can be controlled independently from 3d model
- Details [here](#)

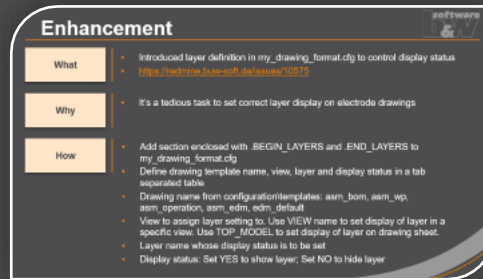

**Enhancement**

**What**

- Introduced layer definition in `my_drawing_format.dwg` to control display status
- <https://redmine.buw-soft.de/issues/10772>

**Why**

- It's a tedious task to set correct layer display on electrode drawings

**How**

- Add section enclosed with `BEGIN_LAYERS` and `END_LAYERS` to `my_drawing_format.dwg`
- Define drawing template name, view, layer and display status in a tab separated table
- Drawing name from configuration/templates: `asm_bom`, `asm_up`, `asm_operation`, `asm_edm`, `edm_default`
- View to assign layer setting to. Use VIEW name to set display of layer in a specific view. Use `TOP_MODEL` to set display of layer on drawing sheet.
- Layer name whose display status is to be set
- Display status: Set YES to show layer; Set NO to hide layer

# Fixed Error

## What

- Command “Attach” fails for quilts with multiple contours
- <https://redmine.buw-soft.de/issues/11708>

## Why

- Starting edges of the boundary loops are not found correctly

## Resolution

- Issue is fixed

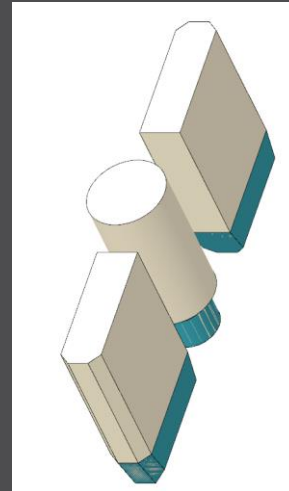
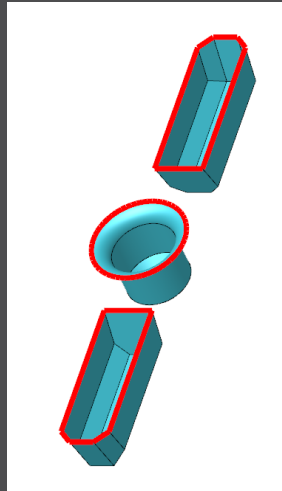
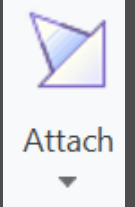



# Fixed Error

## What

- Project UI - skip models without solids during project creation
- <https://redmine.buw-soft.de/issues/11548>

## Why

- Regeneration error occurs if copy-geom, inheritance or merge feature is created for a model without solid geometry

## Resolution

- Models without solid will be skipped during creation of reference part
- An error message will be displayed

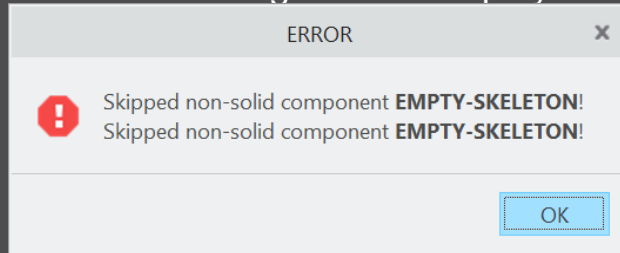

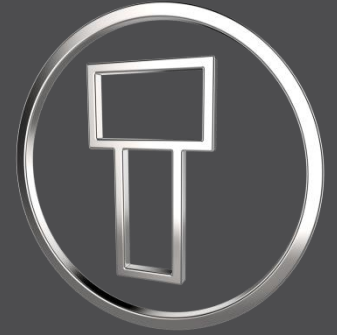

# SMARTElectrode 13.0.1.0

*What's New*

software  
**b&w**

# Improvement

## What

- All configuration files are now considered as encoded in UTF-8
- <https://redmine.buw-soft.de/issues/10943>

## Why

- Necessary for updated interfaces to EDM

## How

- Please use a tool like Notepad++ to convert if necessary
- Files using ASCII standard characters don't need any special handling

# Improvement

## What

- Introduced 'Getting started' document
- <https://redmine.buw-soft.de/issues/10749>

## Why

- This document explains briefly how to start working with SMARTElectrode

## How

- Open 'Getting started' from
  - Installation directory
  - Download server:  
<https://dl.buw-soft.de/smartelectrode/guides/getting-started.pdf>
- Some of the topics covered
  - Configure license / Register and start SE
  - Setting up a configuration / How to use setup wizard
  - Creo options / SMARTElectrode Options
  - Workflow in SMARTElectrode
  - Parameters
  - Base UI
  - Customizing electrode templates
  - Drawing Creation

# Enhancement

## What

- Sort electrodes by parameter value before export
- <https://redmine.buw-soft.de/issues/10575>

## Why

- Some customers need to output electrodes in a specific sort order

## How

- Two new keywords can be used in any export configuration (export.cfg)
  - SE\_ORDER\_BY  
Define parameter by parameter name (1<sup>st</sup> column) or parameter default (last column; include &)
  - SE\_SORT\_ORDER  
Defines sort order: ASC, ASCENDING, DESC, DESCENDING
- Sorting works for strings, doubles and integers
- Only sort by part parameters!

```
SE_ORDER_BY · &BURNAREA_XY
SE_SORT_ORDER · DESCENDING
```

```
SE_ORDER_BY · BRENNFLAECHE
SE_SORT_ORDER · DESCENDING
```

```
BURNAREA · ID · NAME
361.980 · 11 · JS748100_AS_EDM_11
157.062 · 12 · JS748100_AS_EDM_12
156.671 · 12 · JS748100_AS_EDM_12
28.102 · 10 · JS748100_AS_EDM_10
28.102 · 10 · JS748100_AS_EDM_10
25.607 · 3 · JS748100_AS_EDM_03
```

# Improvement

## What

- Consider default action (include/exclude) of simplified representation when valid components for export are collected
- <https://redmine.buw-soft.de/issues/11020>

## Why

- Allow usage of master representation for example

## How

- All valid items in simprep are collected automatically by SMARTElectrode

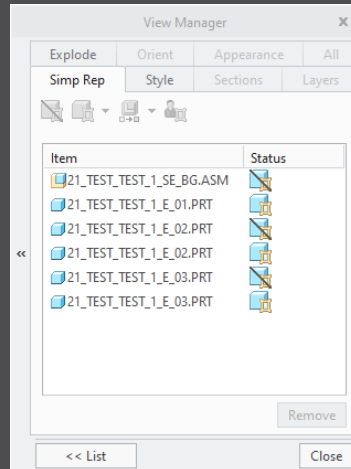

# Improvement

## What

- Updated advanced interface for Zimmer&Kreim Alphamoduli
- <https://redmine.buw-soft.de/issues/7864>

## How

- Processor files include upated list of orbits
- Additional supported XML tags in export
  - MeasDim
  - MeasProgType
  - MeasSizeX
  - MeasSizeY
  - MeasSizeZ
  - MeasZPointX
  - MeasZPointY
  - MeasZPointZ
  - EdgeDistance
  - SafetyDistance
- Please contact us for detailed information and setup!



ZK\_Deutsch.zip



ZK\_English.zip

# Improvement

## What

- Round contour height to even value in Base UI
- <https://redmine.buw-soft.de/issues/5550>

## Why

- For users more interested in an even contour height than in a rounded position

## How

- Mandatory settings:
  - INCREMENT\_POS = 0
  - INCREMENT\_SIZE > 0
- Height of contour will be rounded to a value, where
  - D1 corresponds at least to value in data file
  - D3 corresponds exactly to value in data file
  - Contour height is rounded to INCREMENT\_SIZE
- Should be combined with a free value
  - blank length (LENGTH = -1) or
  - base height (D2 = -1)

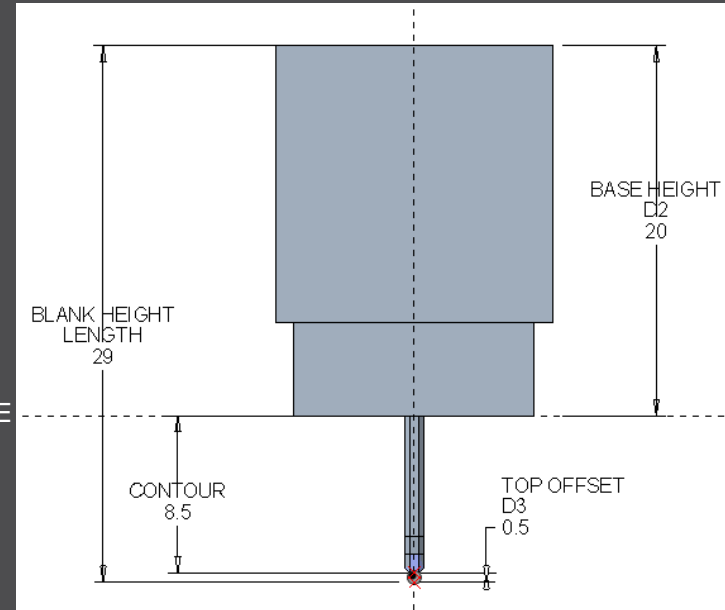



# Improvement

## What

- Show warning in Burnsheat UI if blank length is too small
- <https://redmine.buw-soft.de/issues/8494>

## Why

- Base is **NOT** changed by SMARTElectrode after creation
  - Position of base is retained
  - Size of base is retained

## How

- User is in control whether the base must be revised
- Open Base UI to update values interactively
- Suppress base before Base UI is opened  
→ this starts automatic check and adjustment again

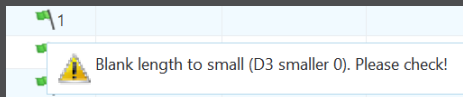

A_BASE	15.000		D1	1.000
B_BASE	15.000		D2	34.000
LENGTH	37.155		D3	-0.700
CHAMFER	<input type="checkbox"/>	Blank length to small (D3 smaller 0). Please check!		
FRAME	<input checked="" type="checkbox"/>	3.200		1.000

# Improvement

## What

- Burnsheet UI / Output UI: electrodes are ordered by feature number per default
- <https://redmine.buw-soft.de/issues/10409>

## Why

- A distinctive electrode sequence is necessary for the output occasionally

## How

- Change order of electrodes in modeltree using drag and drop
- The first appearance of an electrode determines the order for the output

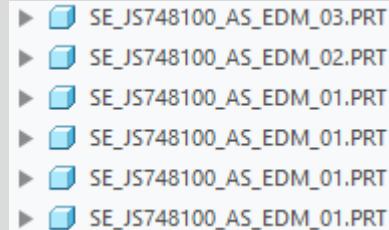

Order in modeltree

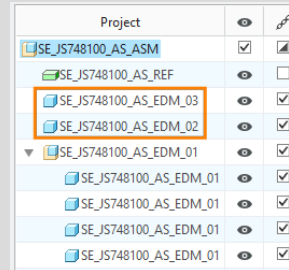

Order in Burnsheat UI

# Improvement

## What











- Show notifications for Burnsheat UI node on mouse-over
- <https://redmine.buw-soft.de/issues/10421>

## Why

- As a quick information for the user

## How

- Move mouse cursor over node if notifications available
- Click on notification to open detailed description in separate window and filter display

Project			Status
 38177-20_SE_BG	<input checked="" type="checkbox"/>	<input type="checkbox"/>	
 38177-20_SE_REF		<input type="checkbox"/>	
 38177-20-061		<input type="checkbox"/>	 1

 Base not centered on solid.

# Improvement

## What

- Use blank dimensions A\_BASE and B\_BASE for coverage check
- <https://redmine.buw-soft.de/issues/10622>

## Why

- CONTACT\_AREA\_MAX\_COVERAGE defines valid percentage of coverage
- SMARTElectrode used area of 'BASE\_TOP' leading to too small areas if clamp is part of electrode

## How

- SMARTElectrode evaluates blank area by base dimensions if available
- 'BASE\_TOP' surface may be used for imported electrodes
- More information about check for calculated burnarea projection:  
<https://redmine.buw-soft.de/issues/10622>

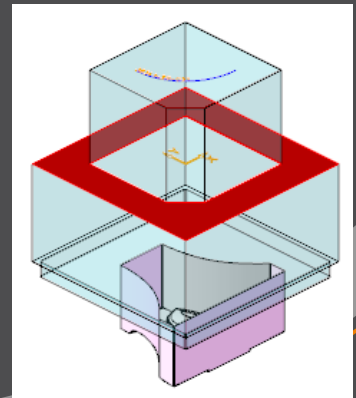

# Improvement

## What

- Allow cancelation of exact burnarea analysis on ESC
- <https://redmine.buw-soft.de/issues/10504>

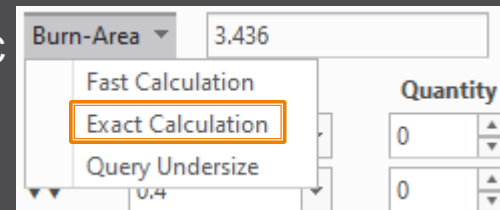

## Why

- Some surface types lead to lengthy analyzes

## How

- Press **ESC** during analysis in Base or Check UI to cancel calculation

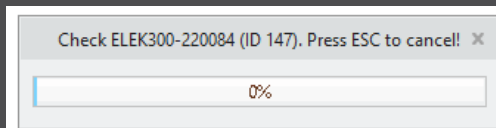

Options				
<input type="checkbox"/>	Interference	<input checked="" type="checkbox"/>	Touching Faces	
<input type="checkbox"/>	Assign Colors	<input type="checkbox"/>	Consider Undersize	
<input type="checkbox"/>	Calculate Undersize	<input checked="" type="checkbox"/>	Effective Contact Area	
Results				
?	Electrode	Touching Surface	Projection Area	Interference
<b>i</b>	SE_JS748100_AS_EDM_01		3.18557	✓
<b>i</b>	SE_JS748100_AS_EDM_01		3.18557	✓
<b>i</b>	SE_JS748100_AS_EDM_01		3.18557	✓
<b>i</b>	SE_JS748100_AS_EDM_01		3.18557	✓
<b>i</b>	SE_JS748100_AS_EDM_02	Cancelled	0	✓
	All	36	12.7423	0

# Improvement

## What

- Allow adjustment of assembly accuracy if inconsistent values are found
- <https://redmine.buw-soft.de/issues/10414>

## Why

- Same accuracy and type should be used in complete assembly
- Inconsistent accuracies may lead to errors

## How

- Warning will be displayed in assembly UI
- Input will be preset to smallest accuracy found
- Additional warning will be shown before creation of reference model
- Errors will be displayed afterwards

- **NOTE**  
SMARTElectrode does not change accuracy of the original models! This is because SE can't evaluate if change of accuracy is allowed.

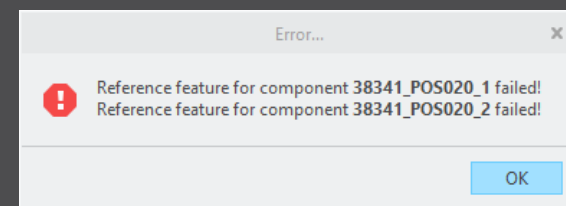
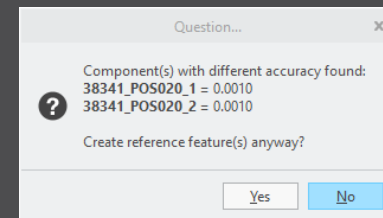
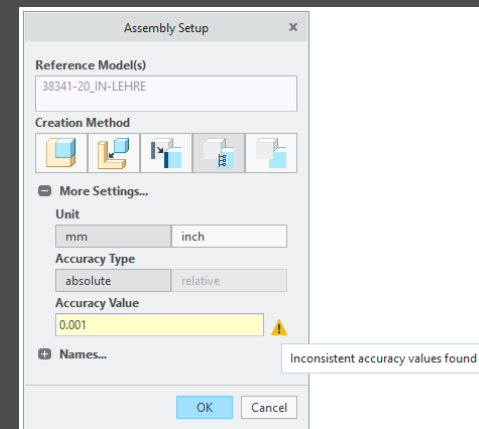

# Improvement

## What

- Use Flexible Modeling 'Substitute' in 'ATTACH' instead of replace
- <https://redmine.buw-soft.de/issues/8703>

## Why

- Normal offset-replace (modeling tab) does sometimes **NOT** unite electrode contour and electrode base, no matter whether FREE\_FACE or solid surface is selected as reference.

## How

- SMARTElectrode automatically uses feature substitute in group 'ATTACH' instead of offset/replace if license for Flexible Modeling Extension is available

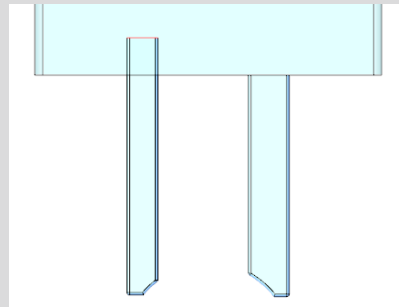

Result for expand

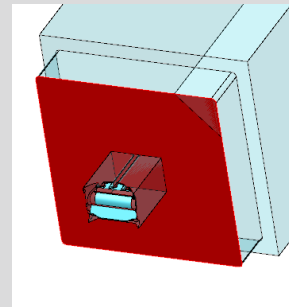

Result for replace

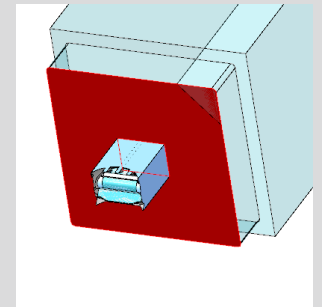

Result for FMX substitute

# Improvement

## What

- Handle existing base for commands 'Pattern' and 'Mirror' in design mode
- <https://redmine.buw-soft.de/issues/8495>



## Why

- Mirror of complete electrode including base may remove chamfers

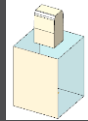

## How

- Command 'Pattern' automatically collects all solid surfaces or surfaces below FREE\_FACE

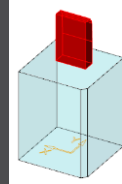

- Command 'Mirror' automatically activates insert mode and adds mirror feature in front of base

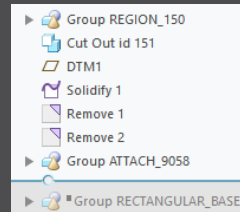



# Improvement

## What

- New commands 'Open Drawing' and 'Open Manufacturing' added to context menu in modeltree and object window
- <https://redmine.buw-soft.de/issues/10411>

## Why

- Easier navigation in electrode assembly

## How

- Commands are only accessible when assembly is active
- Commands are accessible for selected electrode in modeltree and graphics window
- Drawing and manufacturing will be opened in a new window
- If electrode is part of assembly drawing then correct sheet will be shown

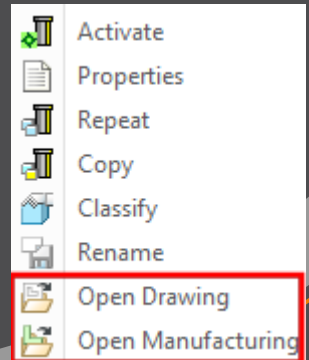

# Improvement

## What

- Introduced new command 'Open Configuration'
- <https://redmine.buw-soft.de/issues/10739>

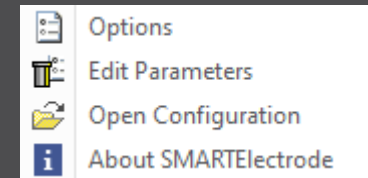

## Why

- Easier access to active configuration

## How

- A file browser opens in active configuration folder
- Actions for selected files / file types
  - parameter.cfg  
Dialog for modification will be opened
  - options.cfg  
Dialog for modification will be opened
  - \*.prt, \*.asm, \*.drw  
Creo file will be opened in a new window
  - any other file  
File will be opened in info window

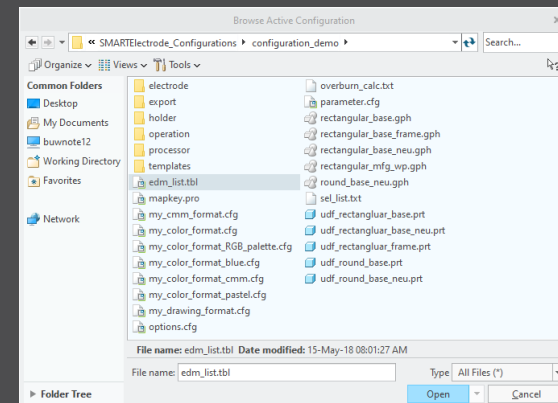

# Improvement

## What

- Disable automatic update of csys on workpiece sides
- <https://redmine.buw-soft.de/issues/10511>

## Why

- User should be in control when dependent operations and electrodes are updated

## How

- The 8 datum points represent the corners of the workpiece outline and can be used for drawing dimensions. These will be updated automatically!
- A notification will be shown in Burnsheat UI for outdated csys
- Double-click in notification details to update csys, operation and electrodes

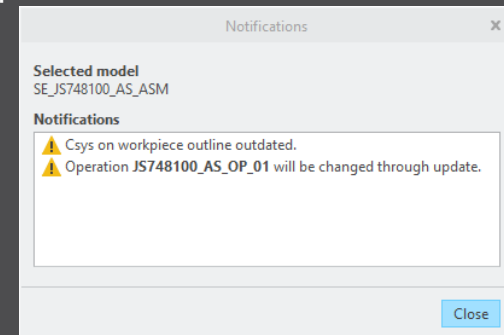
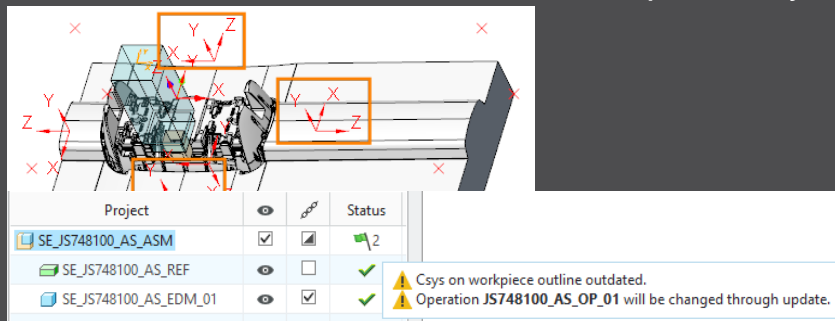
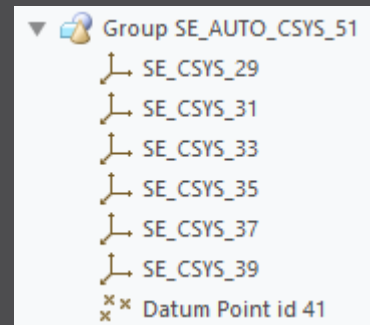

# Improvement

## What

- Repeat UI: only show selected electrodes and preview components when defining new position.
- <https://redmine.buw-soft.de/issues/10399>

## Why

- Improve overview for users if there are many electrodes assembled

## How

- Pre-select electrodes before Assemble Again UI is opened
- Or select in UI (don't forget to confirm selection)
- All electrodes are displayed again on OK or when user starts selection again

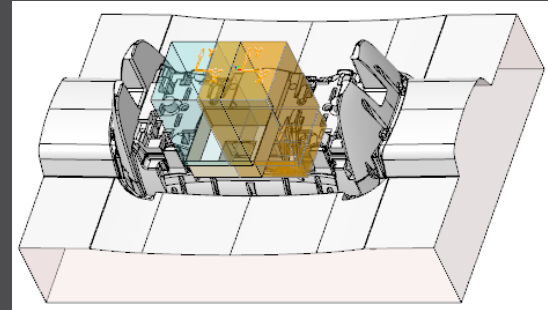
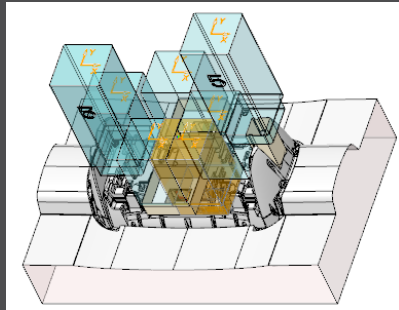

# Improvement

## What

- Use default csys from base to calculate angles
- <https://redmine.buw-soft.de/issues/10822>

## Why

- In some cases, it may be necessary to rotate csys with EDM\_ORIGIN\_NAME
- Angles in burnsheet would appear with wrong values
- Use csys showing orientation of blank for calculation of angles
- Always use 'EDM\_ORIGIN' for electrodes designed in SMARTElectrode 7.0

## How

- Use csys 'SE\_EDM\_BASE' or csys defined in option 'EDM\_ORIGIN\_NAME' for electrodes designed in SMARTElectrode 8.0 – 13.0
- This allows adjustment of csys 'EDM\_ORIGIN\_NAME' for easier definition of start position

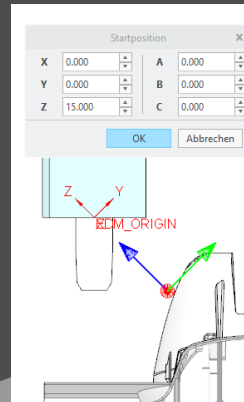
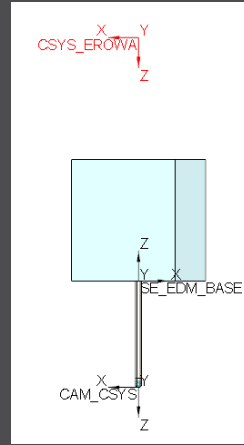

# Improvement

## What

- Allow subgroups in definition of user-defined features for electrode base.
- <https://redmine.buw-soft.de/issues/10389>

## Why

- Sometimes features are nested in groups (MEASURE\_FRAME, FRONT\_NUMBER, FREE\_FACE\_NUMBER) in Base UDF
- These features are currently not considered as part of the base leading to wrong size calculation
- SMARTElectrode now checks all features in base group when checking if a feature/surface is part of base or not.

## How

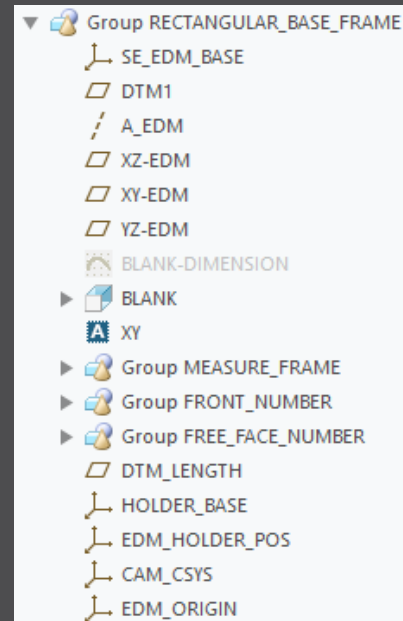

# Improvement

## What

- Check if feature merge in group 'Attach' creates a closed quilt if performed on surface feature or quilt

## Why

- Sometimes merge sets wrong side for 2<sup>nd</sup> quilt to keep
- Leads to an opened quilt which can't be solidified

## How

- SMARTElectrode checks if merge leads to a closed quilt
- SMARTElectrode changes side to keep in merge feature if necessary

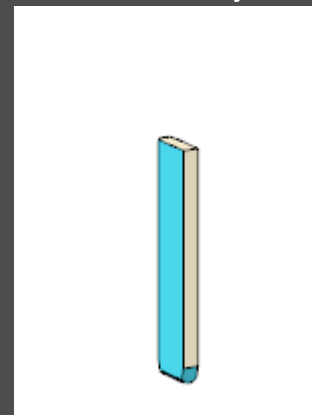
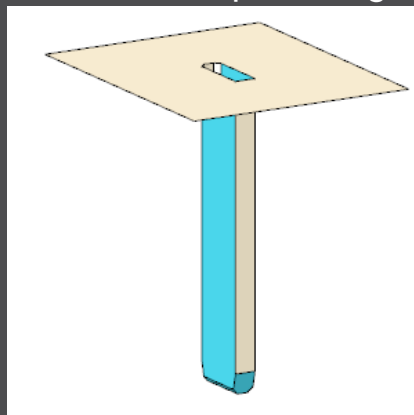
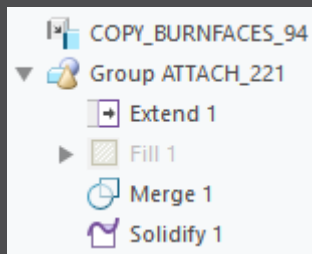

# Fixed Error

## What

- Prevent deletion of active operation
- <https://redmine.buw-soft.de/issues/10733>

## Why

- SMARTElectrode ribbon is disabled after deletion of active operation
- Most of the commands are still accessible but won't work anymore

## Resolution

- SMARTElectrode checks features whether they belong to active operation before deletion
- Deletion will be canceled with message window if feature of active operation selected

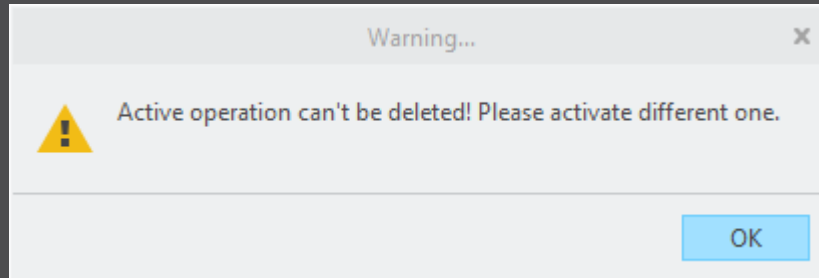



# Fixed Error

## What

- Electrode base with user-defined FREE\_FACE is suppressed to make design changes
- Base is reset to default position when resumed in Base UI

## Why

- Information about user-defined FREE\_FACE gets lost
- SMARTElectrode carries out default process to update base

## Resolution

- SMARTElectrode checks reference of datum FREE\_FACE for changes
- Recognition works for all models with user-defined FREE\_FACE

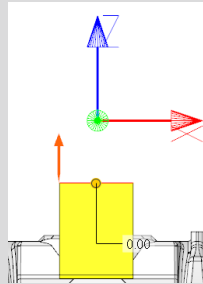

Selected user-defined  
FREE\_FACE

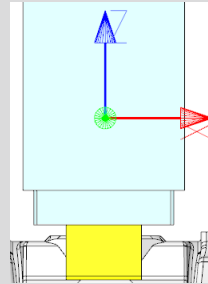

Error on resume in Base  
UI

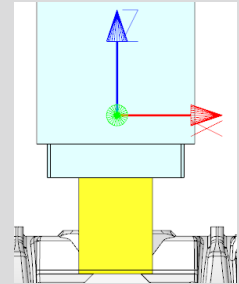

Fix: position is retained

# Fixed Error

## What

- Workpiece dimensions on drawing sometimes incomplete
- <https://redmine.buw-soft.de/issues/10990>

## Why

- Orientations are sometimes not correctly set after drawing creation from template
- For these drawing views sorting of outline points might fail

## How

- Supported symbolic names for drawing orientations
  - 2d view names: SE\_TOP (SE\_DEFAULT), SE\_BOTTOM, SE\_FRONT, SE\_BACK, SE\_LEFT, SE\_RIGHT
  - 3d view names: SE\_DEFAULT\_ISO, SE\_ASM\_DEFAULT, SE\_ASM\_ISO
- Please refer to 'Getting started' document in installation for more information

# Fixed Error

## What

- Fixed wrong creation of ordinate dimensions on drawings
- <https://redmine.buw-soft.de/issues/10685>

## Why

- Multiple redundant baselines without merging dimensions have been created

## How

- This issue is fixed

# Fixed Error

## What

- Reset surface appearance to default before touching faces are colored
- <https://redmine.buw-soft.de/issues/10405>

## Why

- Reset of surface colors is not applicable in all cases

## How

- COLOR\_EDM\_TOUCHING\_FACES has to be available in my\_color\_format.cfg
- A warning will be displayed if 'COLOR\_EDM\_TOUCHING\_FACES' is not applicable
- A distinction is made between the following cases:
  - Check UI: coloring can be done when all electrode positions are selected for touching surface analysis
  - Check UI: a warning will be displayed and coloring will be canceled if NOT all electrode positions are selected for touching surface analysis
  - Base UI: coloring can be done in detailed calculation of contact area if active electrode is used only once in assembly
  - Base UI: a warning will be displayed and coloring will be canceled if active electrode is used multiple times in assembly

# Fixed Error

What

- Fixed wrong result for selection by color
- <https://redmine.buw-soft.de/issues/10857>



Why

- Sometimes too many surfaces have been selected

Resolution

- This issue is fixed

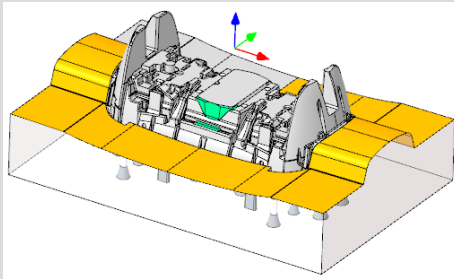

Original

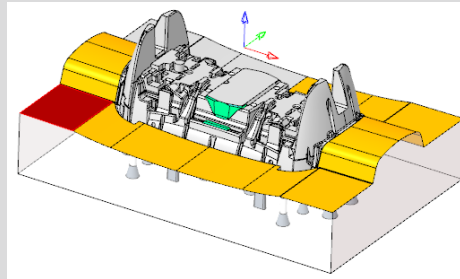

Selected reference

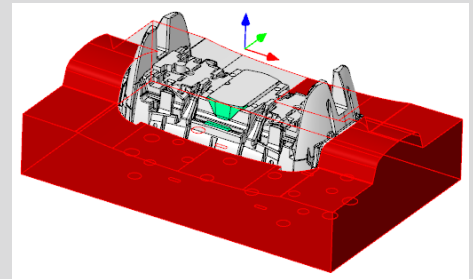

Wrong result

# Fixed Error

## What

- Hide invalid commands in modeltree
- <https://redmine.buw-soft.de/issues/10985>

## Why

- Some commands are invalid in modeltree context menu if selected feature is not inside active component

## How

- This issue is fixed

# Fixed Error

## What

- Commands can be selected from context menu for suppressed electrodes
- Applies to Creo Parametric 4.0 and 5.0
- <https://redmine.buw-soft.de/issues/10518>

## Why

- Component selections are not automatically skipped in above Creo versions

## Resolution

- Issue is fixed
- Commands are removed for suppressed features

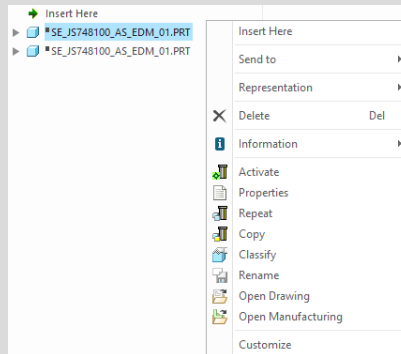

Before

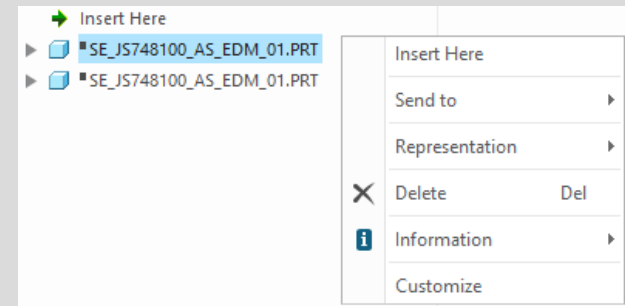

After

# Fixed Error

## What

- Crash in Base UI if no workpiece model found
- <https://redmine.buw-soft.de/issues/10488>

## Why

- It's not possible to read workpiece information if no component in assembly is marked as workpiece
- Parameter `SE_CORE_MODEL=1` not available

## Resolution

- Issue is fixed
- Always check if an active workpiece can be found and cancel functionality if necessary



# Fixed Error

## What

- Command 'New with Base' does not work anymore
- <https://redmine.buw-soft.de/issues/10407>

## Why

- SMARTElectrode checks selected template for completeness before its used
- This includes check for parameters
  - SE\_EDM\_SUPPLIER
  - SE\_EDM\_TYPE
- Command is canceled if any expected parameter is missing

## Resolution

- Issued is fixed
- SMARTElectrode extracts supplier and type from selected data file:  
configuration/electrode/<supplier>/<type>.dat

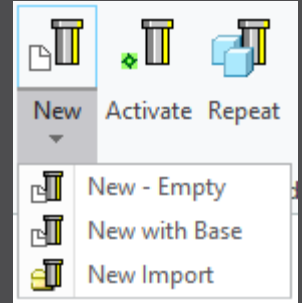

# Fixed Error

## What

- Help does not open if path contains spaces or special characters.

## Resolution

- Issue is fixed.

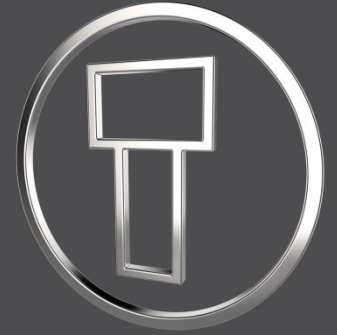

# SMARTElectrode 13.0.0.0

*What's New*



# Multibody support

## What

- Support for new multibody features introduced in Creo Parametric 7.0 [<https://redmine.buw-soft.de/issues/9973>]

## Who needs it

- All customers working with Creo Parametric 7.0

## Details/Usage

- SMARTElectrode supports multibody features in following modes/models/features:
- Assembly creation for all available methods (original model, merge, copy-geom, inheritance)
  - Electrode design
    - Features creating a solid are automatically created in default body or body selected implicitly by references
    - Features without geometrical references like base or support are created in active or default body

## Impact/ Compatibility

- Additional features may be added with new releases from PTC

# Improvement

## What

- Added threshold to show a warning if contact area covers more than defined percentage of blank area  
[\[https://redmine.buw-soft.de/issues/10357\]](https://redmine.buw-soft.de/issues/10357)

## Who needs it

- Users who output effective contact area for EDM programming

## Details/Usage

- SE performs a fast contact area calculation when Base UI is opened and contact area is 0
- Slower more exact calculation can be started by user in UI
- Check UI always performs the exact calculation
- Option “CONTACT\_AREA\_MAX\_COVERAGE” defines valid percentage
- Warnings are shown in Base UI and Burnsheat notifications

CONTACT_AREA_MAX_COVERAGE	80	Maximum valid coverage of the blank area with contact areas in percent.
---------------------------	----	-------------------------------------------------------------------------

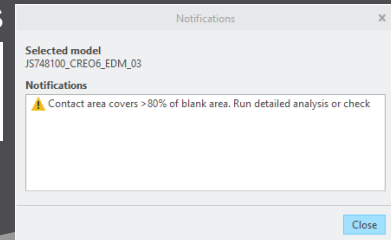
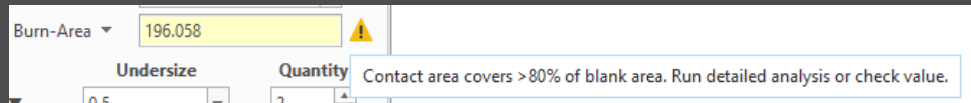

# Fixed error

## Description

- Edited base values are reset on next change  
[<https://redmine.buw-soft.de/issues/10218>]

A_BASE	17.500	▲▼	D1	5.128	▲▼
B_BASE	15.000	▲▼	D2	40.000	▲▼
LENGTH	48.000	▲▼	D3	0.022	▲▼

A_BASE	15.000	▲▼	D1	5.128	▲▼
B_BASE	15.000	▲▼	D2	35.000	▲▼
LENGTH	43.000	▲▼	D3	0.022	▲▼

## Cause

- Edited values are not correctly saved to template data

## Solution

- Problem is fixed

# Fixed error

## Description

- Some electrodes are not processed during output [<https://redmine.buw-soft.de/issues/10191>]

## Cause

- SE validates every electrode during export and skips suppressed, disabled or incomplete components.
- Check for completeness includes a check of electrode base group
- Check for completeness fails on imported or legacy electrodes as base is not created by UDF.

## Solution

- SE now looks for existence of mandatory EDM coordinate system
- Legacy electrode use “EDM\_ORIGIN” or “EDM\_ORIGIN\_TOP” depending on option value “USE\_POS\_CSYS\_TOP”
- Electrodes beginning with version 8.0 use csys name defined in option “EDM\_ORIGIN\_NAME”