

SMARTUpdate 10.0.0.0

What's New?



Enhancements

Introduce Body Check to update body properties:

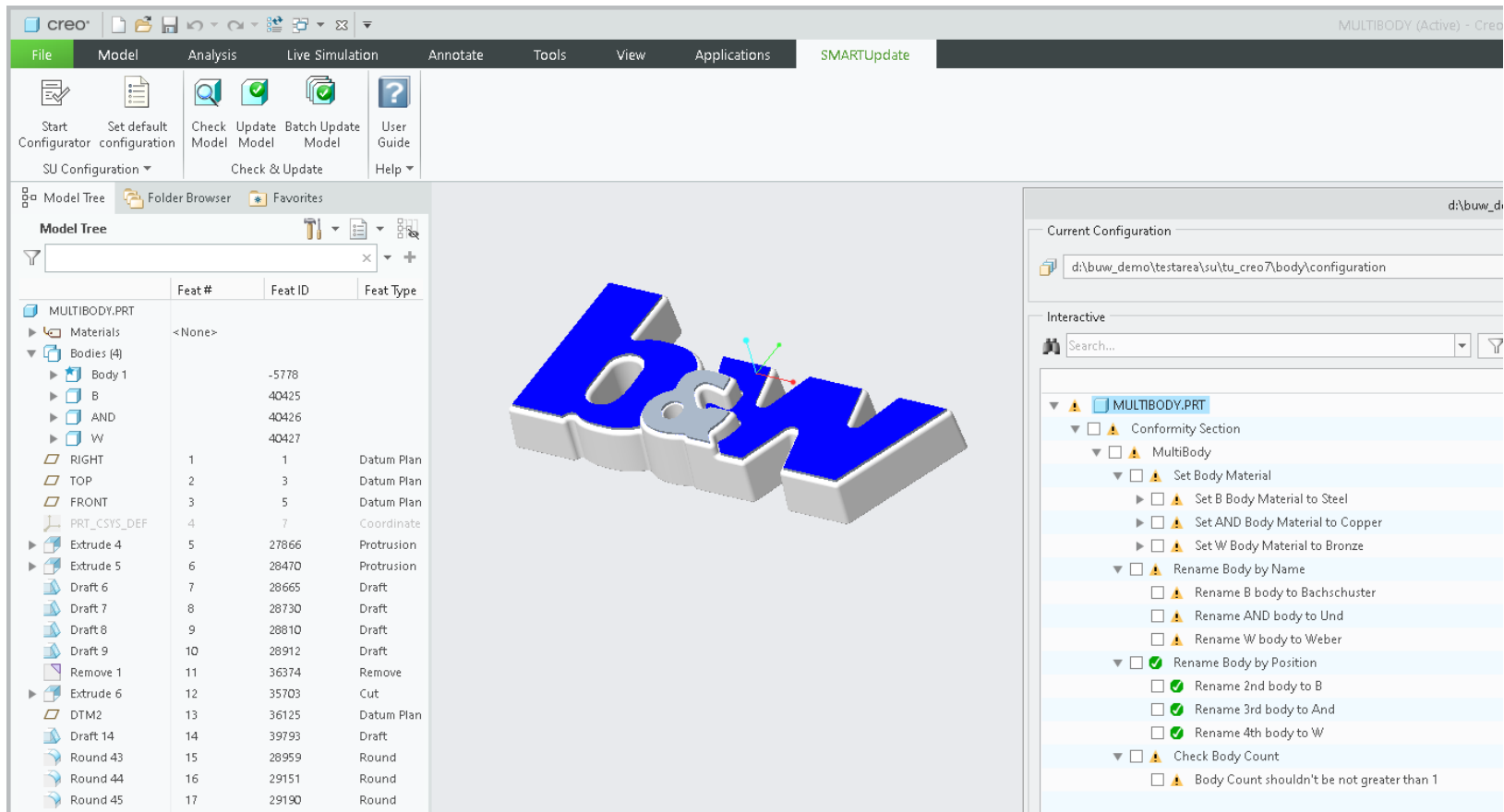

The screenshot displays the Creo software interface with the 'SMARTUpdate' menu open. The 'Body Check' option is highlighted. The 'Body Check' dialog box is visible, showing the 'Current Configuration' and 'Interactive' sections. The 'Body Check' dialog box is titled 'MULTIBODY (Active) - Creo' and shows the following configuration:

Current Configuration: d:\bw_demo\testarea\su\tu_creo7\body\configuration

Interactive: Search...

MULTIBODY.PRT

- Conformity Section
 - MultiBody
 - Set Body Material
 - Set B Body Material to Steel
 - Set AND Body Material to Copper
 - Set W Body Material to Bronze
 - Rename Body by Name
 - Rename B body to Bachschuster
 - Rename AND body to Und
 - Rename W body to Weber
 - Rename Body by Position
 - Rename 2nd body to B
 - Rename 3rd body to And
 - Rename 4th body to W
 - Check Body Count
 - Body Count shouldn't be not greater than 1

Enhancements - Body

Update material for every single body:

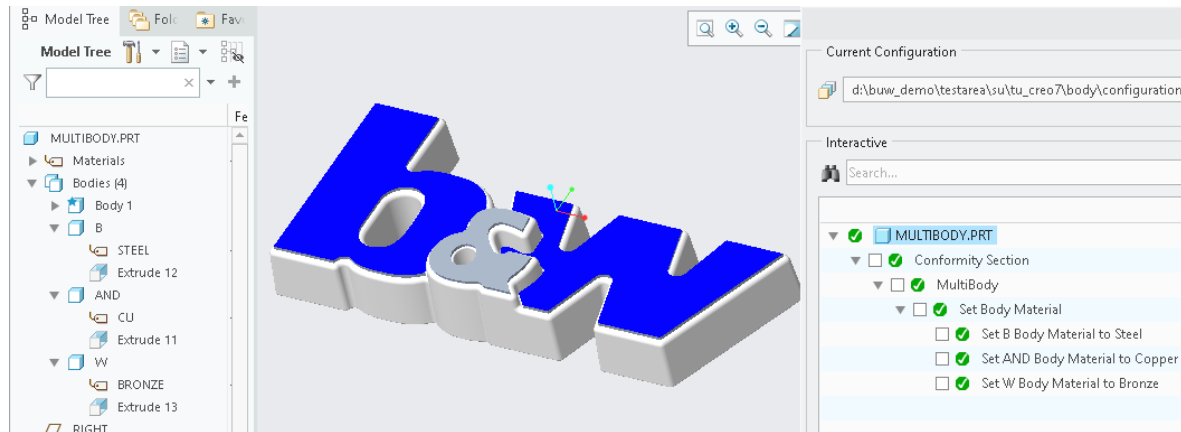
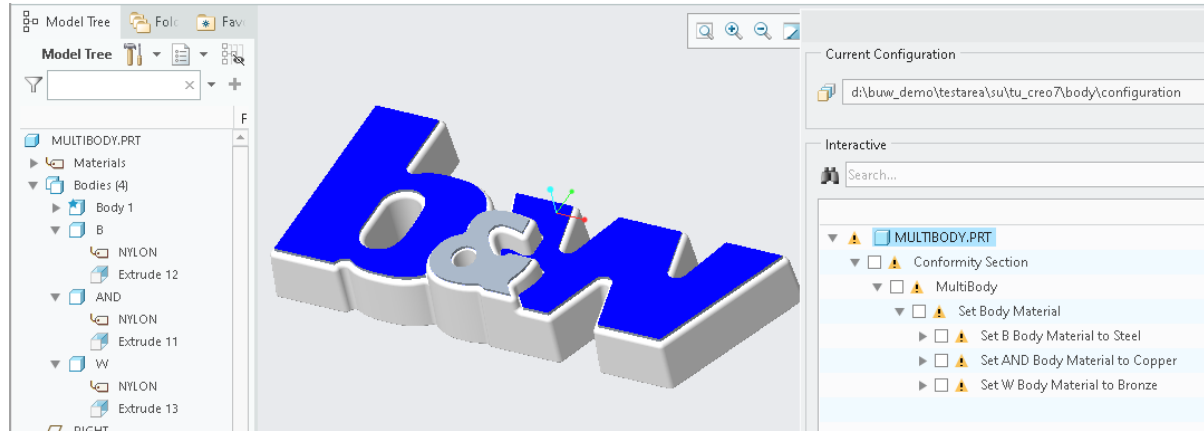

Enhancements - Body

Find bodies by name and rename them:

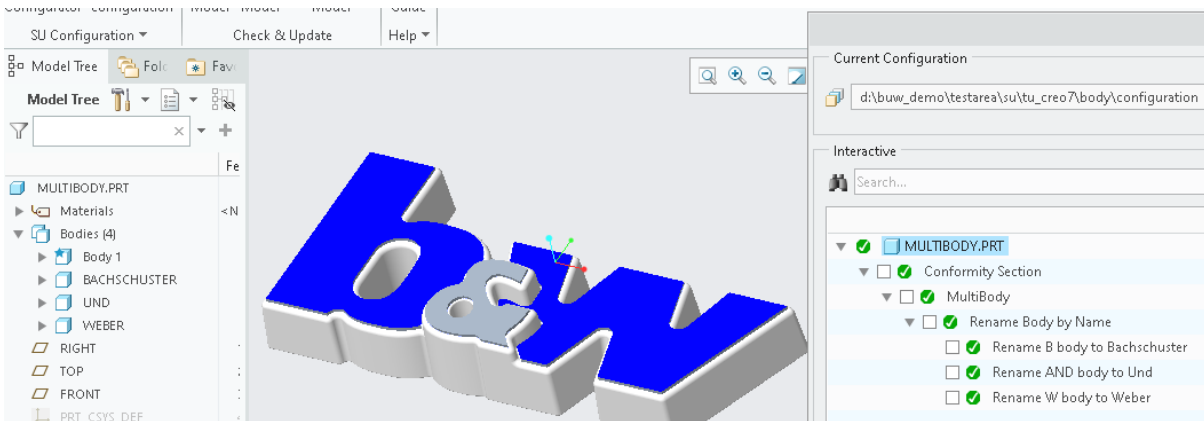
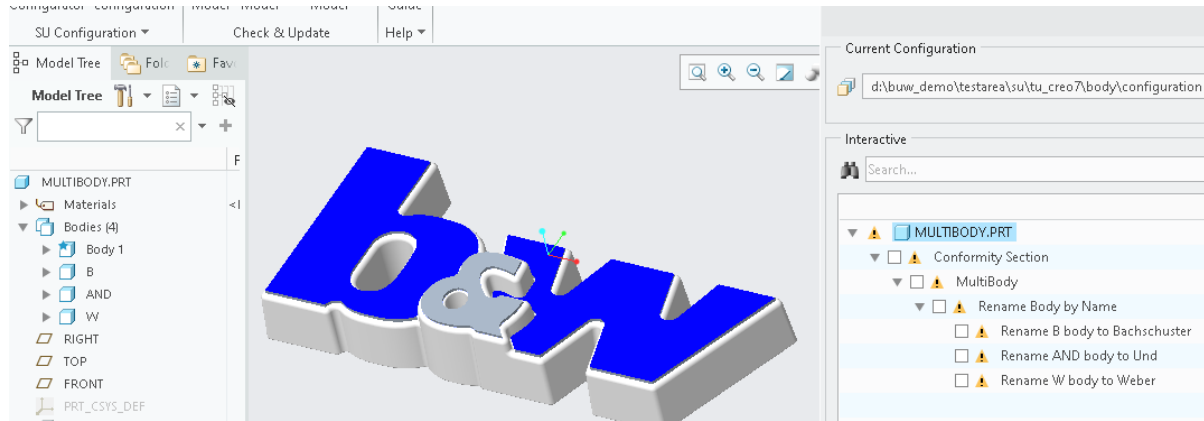

Enhancements - Body

Find bodies by position and rename them:

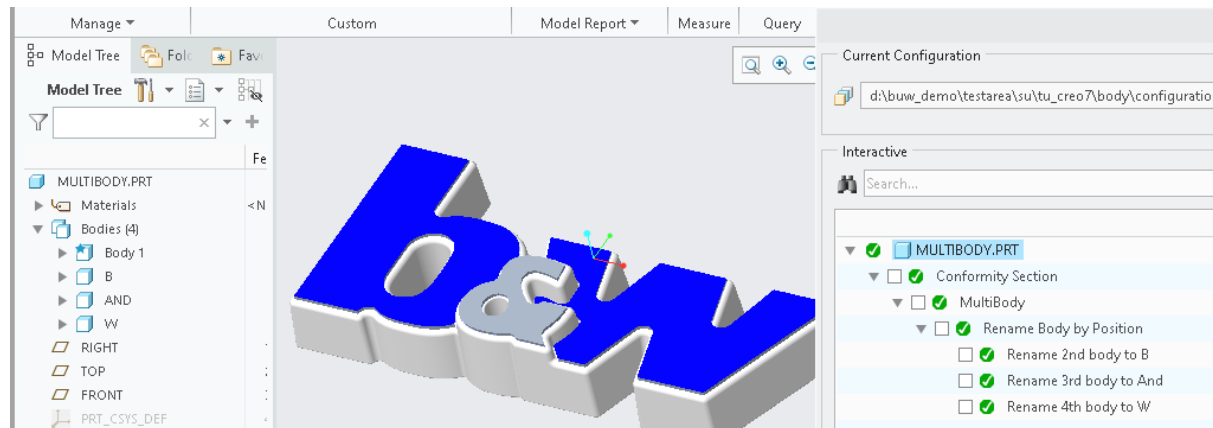
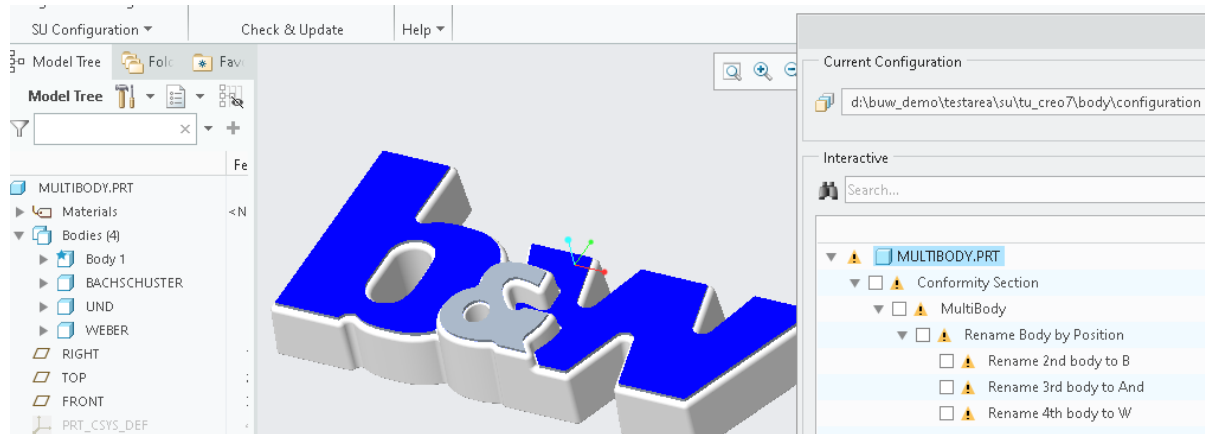

Enhancements - Body

Check the number of bodies to not exceed a maximum count:

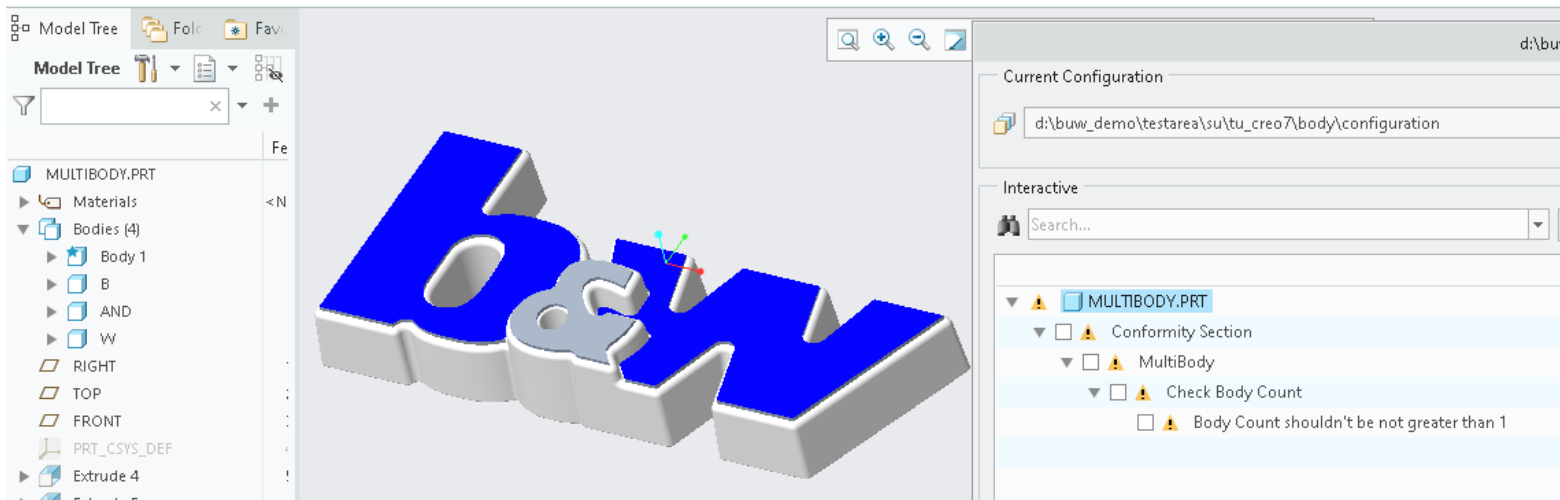

Enhancements

Change parameters in family tables:

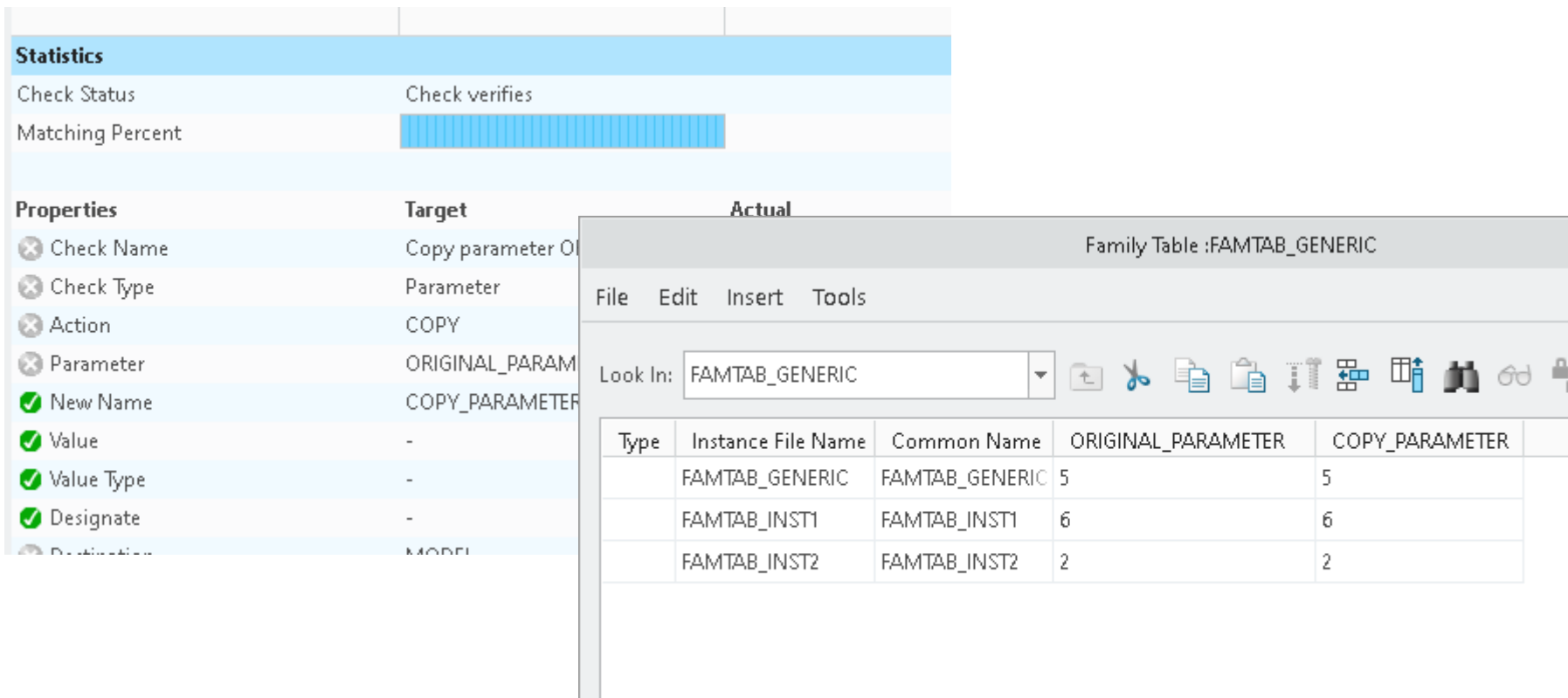

Statistics

Check Status: Check verifies

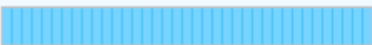
Matching Percent: 

Properties	Target	Actual
<input checked="" type="checkbox"/> Check Name	Copy parameter Of	
<input checked="" type="checkbox"/> Check Type	Parameter	
<input checked="" type="checkbox"/> Action	COPY	
<input checked="" type="checkbox"/> Parameter	ORIGINAL_PARAM	
<input checked="" type="checkbox"/> New Name	COPY_PARAMETER	
<input checked="" type="checkbox"/> Value	-	
<input checked="" type="checkbox"/> Value Type	-	
<input checked="" type="checkbox"/> Designate	-	
<input type="checkbox"/> Destination	MODEL	

Family Table :FAMTAB_GENERIC

File Edit Insert Tools

Look In: FAMTAB_GENERIC

Type	Instance File Name	Common Name	ORIGINAL_PARAMETER	COPY_PARAMETER
	FAMTAB_GENERIC	FAMTAB_GENERIC	5	5
	FAMTAB_INST1	FAMTAB_INST1	6	6
	FAMTAB_INST2	FAMTAB_INST2	2	2

Enhancements – Family Tables

Add new parameters to family tables:

Label	Value
Check Name	Add Parameter BUW_FAMTAB to family table
Check Type	Parameter
Action	CREATE
Parameter	BUW_FAMTAB
RegEx	<input type="checkbox"/>
Value	1
Value Format	-
Value Type	-
Designate	-
Destination	MODEL
Description	-
Add Column to Family Table	<input checked="" type="checkbox"/>
Should belong to Family Table	-

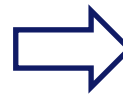

Family Table :MULTIBODY

File Edit Insert Tools

Look In: MULTIBODY

Type	Instance File Name	Common Name	BUW_FAMTAB
	MULTIBODY	multibody.prt	1
	MULTIBODY_INST	multibody.prt_INST	1

d:\buw

Current Configuration

d:\buw_demo\testarea\su\tu_creo7\body\configuration

Interactive

Search...

- MULTIBODY.PRT
 - Conformity Section
 - Parameter
 - Add Parameter BUW_FAMTAB to family table

Enhancements – Family Tables

Add new parameters to family tables:

Family Table :MULTIBODY

File Edit Insert Tools

Look In: MULTIBODY

Type	Instance File Name	Common Name	BUW_FAMTAB
MULTIBODY	multibody.prt		1
MULTIBODY_INST	multibody.prt_INS		1





d:\buw_demo\test

Current Configuration

d:\buw_demo\testarea\sut\tu_creo7\body\configuration

Interactive

Search...

-  MULTIBODY.PRT
 -  Conformity Section
 -  Parameter
 -  Change value of BUW_FAMTAB Parameter within the family table



Family Table :MULTIBODY

File Edit Insert Tools

Look In: MULTIBODY

Type	Instance File Name	Common Name	BUW_FAMTAB
MULTIBODY	multibody.prt		2
MULTIBODY_INST	multibody.prt_INS		2





d:\buw_demo\test

Current Configuration

d:\buw_demo\testarea\sut\tu_creo7\body\configuration

Interactive

Search...

-  MULTIBODY.PRT
 -  Conformity Section
 -  Parameter
 -  Change value of BUW_FAMTAB Parameter within the family table

Enhancements

Update drawing notes at a specific position in a drawing table:

Row 7, Column 1		
MATERIAL :	-	
HARDNESS :	-	
HARD. DEPTH :	-	
UNSPEC. TOL. :	-	
SCALE :	1:1	SHEET
UNIT :	MM (METRIC)	A3
DRAWN BY :	FITu	
DATE :	16.07.2020	

Label	Value
Check Name	Edit DATE note
Check Type	Drawing Note
Action	EDIT
Drw. Note Line	-
Drw. Note Table ID	*
Drw. Note Table Row	7
Drw. Note Table Column	1
Drw. Note New Line	&DATE
Drw. Note Parameter	DATE
RegEx	<input type="checkbox"/>